

EGS | Kataloog 2010/2011



lülitid, pistikupesad ja juhtimissüsteemid

Tere tulemast klienditeenindusse

Teeninduse telefon: 0 23 73 / 89-1500

Faks küsimuste esitamiseks: 0 23 73 / 89-77 77

Faks tellimuste esitamiseks: 0 23 73 / 89-77 55

e-post: info@obo.de











Internet: www.obo.de



Kasutage OBO klienditeeninduse otsetelefoni! Klienditeeninduse telefonil 02373/89-1500 oleme teile iga päev kättesaadavad kella 7.30 kuni 17.00 ning vastame kõigile küsimustele, mis puudutavad OBO elektripaigalduse programmi. Uue struktuuriga OBO klienditeenindus pakub teile täisprogrammi:

- Kompetentsed kontaktsikud teie regioonist
- Kogu info OBO tootevaliku kohta
- Asjatundlikud nõuanded konkreetse kasutamise kohta
- Kiire ja vahetu juurdepääs kõigi OBO toodete tehniliste andmete juurde - ka kliendiläheduse poolest soovime olla parim!

Sisukord

	projekteerimisabi	5
	Modul 45 pistikupesasüsteemid	51
	Modul 45 connecti pistikupesasüsteemid	59
	Modul 45 lülitus- ja ühendussüsteemid	63
	Modul 45 andmetehnikasüsteemid	73
	Modul 45 süvistatavad ja pinnapealsed adaptersüsteemid	81
	Töökohasüsteemid	91
	tööstus-ja spetsiaalpestik-süsteemid	97
	Energiajaotursüsteemid	107
	Kataloogid	115



OBO EGS-seminarid: teadmised algallikast

Ulatuslik koolitus- ja seminariprogramm paigaldusseadmesüsteemide kohta, mis toetab OBO kasutajaid algallikast pärit erialateadmistega. Lisaks teoreetilistele alustele räägitakse ka praktilisest kasutamisest igapäevaelus. Konkretsed kasutus- ja arvutusnäited täiustavad pakutavat veelgi.

Hangete tekstid, tooteinfo ja andmekaardid

Teeme teie elu lihtsamaks: ulatuslik valik praktilistelt ettevalmistatud materjalidest, mis toetavad teid tõhusalt juba ettevalmistuse ajal, näiteks projekteerimisel ja projekti kalkuleerimisel. Nende hulka kuuluvad:

- hangete tekstid
- tooteinfo
- märgulehed
- andmekaardid

Dokumente uuendatakse pidevalt ning neid saab igal ajal tasuta alla laadida internetiaadressilt www.o-bo.de.

Hangete tekstid internetis aadressil www.ausschreiben.de

Tasuta kättesaadav enam kui 10 000 sissekannet valdkondadest KTS, BSS, TBS, LFS, EGS jd UFS. Regulaarsed uuendused ja laiendused võimaldavad saada pidevat ulatuslikku ülevaadet OBO toodetest. Saadaval on kõiklevinud failivormingud (PDF, DOC, GAEB, HTML, TEXT, XML, ÖNORM). www.ausschreiben.de

Projekteerimis- ja montaažiabide sisukord

	üldine projekteerimisabi	6
	Modul 45 pistikupesasüsteemid	11
	Modul 45 connecti pistikupesasüsteemid	15
	Modul 45 lülitus- ja ühendussüsteemid	21
	Modul 45 andmetehnikasüsteemid	27
	Modul 45 süvistatavad ja pinnapealsed adaptersüsteemid	35
	tööstus-ja spetsiaalpestik-süsteemid	43
	Lähem info	48



Modul 45 põhimõte



Üks kõige jaoks.

Uus lihtsus

Iga hoone elektrisüsteem vajab individuaalset lahendust. Modul 45 seeria abil võimaldab OBO alati leida funktsionaalse ja esteetiliselt veenva lahenduse. Sest Modul 45 on universaalselt kasutatav: seadmekarbiutes, põrandapaigaldussüsteemides, karbikpostisüsteemides ning ka süvistatavate ja õõnesseinalahenduste korral. Adapterite ja paigaldusseadmetooside abil saab Modul 45 paigaldusseadmeid kasutada ka 80-se kaanega LFS-süsteemides. Koos karbikute ja katteraamidega tekib süsteem, kus kõik omavahel täpselt sobib ning mida saab igal ajal vähese vaevaga uutele tingimustele kohandada. Lülitid, pistikupesad ja andmetehnika vajutatakse lihtsalt sisse. Nii kiire ja lihtne pole seadmete monteerimine veel kunagi olnud.

Modul 45 eelised ülevaatlilikult:

- Moodulehitus
- Lihtne ja kiire planeerimine
- paigaldussõbralik
- Suur tõhusus tänu aja ja kulude kokkuhoiule
- Mitmekülgsed kasutusvõimalused
- vähene ruumivajadus
- kerge vahetada
- paindlik kohanemisvõime
- kena disain

Modul 45 OBO süsteemikeskkonnas



Üks kõige jaoks.

Seadmekarbi 80mm kaaneava-ga.

Absoluutne paigaldussõbralikus, moodulsüsteem ja praktilised materjalid - see iseloomustab plastist, terasplekist ja alumiiniumist seadmekarbiuid. Seadmetosi ja katteraami abil saab paigaldada ka Modul 45 seadmeid

Deskbox

Kõige paremini varustatud: Deskboxi saab varustada eraldi Modul 45 andme- ja sideühenduspesadega, pistikupesadega ja lülititega. Deskbox rikastab oma elegantselt hoogsa vormiga kirjutuslauda.

Karbi-post

Ilusamini energia voolata ei saa: OBO paigaldussüsteemid ISS võimaldavad paigaldada varustuskohti vabalt töökoha lähedusse. Modul 45 paigaldusseadmetega on paindlik tulevik alati juba paigaldatud.

Seadmekarbid Rapid 45

Lihtne paigaldus, täiuslik välimus: seadmekarbi Rapid 45 on universaalselt kasutatav. Seda saab paigaldada tavapärast ja sokkellist karbikuna ning see pakub suurele hulgale kaablitele palju ruumi. Vaid ühe käeliigitusega saab karbikusse paigaldada lülitid ja pistikupesad koos kõige muu juurdekuu-

luvaga.

põrandas-paigaldussüsteemid

OBO põrandaspaigalduse süsteemid pakuvad mugavat ja ohutut juurdepääsu elektrivarustusele, siseteltele ja välistele andmevõrkudele ning telekommunikatsioonile. Eriti elegantne: peidetud juhtmed. Modul 45-ga ühilduv pogrammsaldab lahendusi kõigile põrandaliikidele ja kasutusvaldkondadele.

süvis- ja õõnesseinasüsteemid

Modul 45 paigaldusseadmed muutuvad üha populaarsemaks. OBO leevendab üha kasvavat nõudlust praktiliste komponentide järele uute lahenduste ja toodetega: tänu süvistatavatele ja õõnesseinalahendustele tekivad uued paigaldusvõimalused.

Energiavarustusüksused

Kõik hea tuleb ülevalt: äärmiselt tugevad ja tööstuses kasutamiseks sobivad energiatoiteüksused ripuvad laes. Seda saab varustada Modul 45 seadmetega ning see pakub ühendusvõimalusi elektrile, andmetehnikale ja suruõhule. Saadaval on ka eelmonteeritud ja kaabeldatud moodulid.





Milline raha- ja ajavõit kaasneb Modul 45 süsteemiga?



Kiire ja soodne paigaldusviis.

Aeg on soodne

Modul 45 süsteem muudab töö igas projektifaasis kiiremaks ja seega odavamaks. Tänu ühtsetele paigaldusmõõtmetele ning komponentide ja tarvikute rohkusele saab seda süsteemi kõige erinevamal viisil kasutada. See kiirendab projekteerimist, mis on otsustav konkurentsieelis, kui tegemist on kiirete tähtaegadega. Ka oma lao- ja logistikakulusid saate vähendada: vajate vähem eri tootjate eri süsteeme. Ning klikkinnitusega tehnika tagab selle, et paigaldamine ja hilisemad muudatused on kiiresti teostatavad.

Aja kokkuhoid Plug & Play abil

Uue pistikupesasüsteemi Modul 45connecti abil pakub OBO aja- säästlikku, lihtsat ja turvalist elektripaigalduse võimalust. GST18i pistikusüsteemi adapter vajutatakse lihtsalt pistikupesale ning see võimaldab VL-pikenduskaablite abil vooluvarustuse kiiret ühendamist ja edasisuunamist. Aeganõudvad tööetapid pistikupesade ühendamisel, näiteks kaablilt isolatsiooni eemaldamine, juhtmete ühendamine ja tõmbetakistuse paigaldamine, jäävad ää.

Põhimõte, mis tasub ära

Paigaldus- ja montaažiajad on tänapäeval lisaks funktsioonile ja disainile toote olulised kvaliteeditunnused. Modul 45 süsteem lihtsustab paigaldust ja vähendab seeläbi montaažiaegu. Seadmete paigalduse, eemalduse ja vahetusega kaasnev kulu on võrreldes tavalise paigaldusega oluliselt väiksem. Otsustav eelis: lüliti, pistikupesa ja muu vajutatakse lihtsalt ühe käelliigutusega süsteemikeskkonda – tulemuseks on täiuslik, kaunis ja praktiline paigaldis.

Milline on Modul 45 süsteemi jaoks ideaalne paigaldussüsteem?



Unistuste kooslus: Rapid 45 ja Modul 45 süsteem

Teineteise jaoks loodud: Rapid 45 ja Modul 45 süsteem

Seadmepaigalduskarbid Rapid 45 ja 45 mm kaaneavaga karbikpostid on välja töötatud spetsiaalselt Modul 45 paigaldusseadmetele: kaasaegse, saleda disaini ja ajakohase ökonoomse paigalduse täuslik koosmäng. Montaažiks pole vaja lisadetaile nagu seadmetoosid, adapterid või katteraamid. Paigaldusseadmed vajutatakse otse kaaneavasse ning moodustavad seega ületamatu duo.

Markantne: GEK-seadmekarbik Rapid 45

Rapid 45 iseloomustab kaldus ülaservadega markantne vorm. Tänu anodeeritud pealispinnale saab Rapid 45 Alumiiniumi probleemideta integreerida kvaliteetsisustusega kontoritesse. Karbik on saadaval kahes suuruses: mono- ka duokarbikuna.

Kaunilt sale

ISS 45ne kaaneava Ainult 70 mm läbimõõt annab ISS Modul 45 süsteemi alumiiniumprofiilile saleda välimuse. Esiosal asub kaaneava Modul 45 süsteemi lülitus- ja pistikseadmete vahetuks paigaldamiseks. Seda katab täielikult alumiiniumkate. Nii saab võimalikuks eriti sale vorm.



testitähis

	STOWARZYSZENIE ELEKTRYKÓW POLSKICH, Polen
	KEMA-KEUR, Holland
	Österreichischer Verband für Elektrotechnik, Austria
	Verband der Elektrotechnik, Elektronik, Informationstechnik e.V., Saksamaa



sümbolite selgitus

pealispinnad

 FS	tsingitud lintmeetodil
--	------------------------

Vastavuse tähis

 CE	Communauté Européenne, EG vastavusdeklaratsioon vastavalt EG direktiividele
--	---

kvaliteedimärk

	halogeenivaba; kloori, fluori ja broomita
---	---

	UV-KINDEL
---	-----------

Spetsiifilised tootetähised

	läbimõõt 60 mm
---	----------------

	läbimõõt 68 mm
---	----------------

	kaitseseade vastavalt standardile DIN EN 61643-11 ja IEC 61643-11
---	---

	üleminek variandilt LPZ 2 variandile 3
---	--

	akustiline signalisatsioon
---	----------------------------

metallmaterjalid

	Alumiinium
---	------------

	teras
---	-------

plastmaterjalid

	polüamiid
---	-----------

	polükarbonaat
---	---------------

	polüetüleen
---	-------------

	Polüpropüleen
---	---------------

	Polüstüreen
---	-------------

	Polüvinüülkloriid
---	-------------------





Lühiinfo

Töökohtade varustamiseks saab kasutada püsi- ja pistikühendusega energiajaotureid. Kõik pistikühendused on varustatud pistikusüsteemiga GST18i ja tõmbetakistiga. Kui eri vooluahelaid ja/või side- ja andmesideühendusi on vaja ainult töökohta ühes varustuspunktis, võib kasutada Consolidation Pointi. Selle korpus on ette valmistatud modul 45 paigaldusseadmete paigaldamiseks.





süsteemi komponendid

Consolidation Point
energiajaotur
Pistik/pesa
Pikendusjuhtmed

Süsteemi kirjeldus

Consolidation Point
Materjal: Tsingitud terasplekk
Seadmepaigaldus: Modul 45 seadmed
Sisend: püsiühendus klemmplokiga (5 poolusega või otse ühendusseadmetele)
Energiajaotur
Materjal: tsingitud terasplekk
Seadmepaigaldus: pole võimalik, standardvarustuses GST18i pistikusüsteem
Sisend: püsiühenduse korral 5 poolusega klemmplokiga, pistikühenduse korral 5 poolusega pistikühendusega, tüüp GST18i, 1 või 2 pöördvooluahelat
Väljund: 6 või 2 x 6 pistikühendust (3 poolust), tüüp GST18i

Energiajaotursüsteemid

	Consolidation Point	Tühi korpus Modul 45 kandurplaat Kandurplaar Blindplatte Klemmleiste	108
	Energiajaotur	Energiajaoturid, püsühendus Energiajaotur, pistikühendus	109
	Ühendustarvikud	3 poolusega pistik 3 poolusega pesa 3 poolusega jaotusplokk 5 poolusega pistik 5 poolusega pesa	110
	pikendusjuhe	Pistik-pesa, 3 poolusega Pistik-pesa, 3 poolusega, halogeenivaba	112

Consolidation Point



tühi korpus

Tüüp	Pak. tükk	kaal kg/100 tk	Art-nr.
CP45-LG 8A	1	190,000	6108 03 7

St teras €/tk

Consolidation Pointi tühi korpus 4 Modul 45 seadme paigaldamiseks (laiendatav kuni 8 Modul 45 seadmeni), mis koosneb kopruse alumisest osast ja kaanest, kattekaas andmeside ja tugevvoolu eraldamiseks, 2 kandeplaadist kummalegi 2 Modul 45 seadme paigaldamiseks, 2 pimeplaati, 2 hülssihendit V-TEC M25 ja üks kaitsejuhi ühendusnurk.

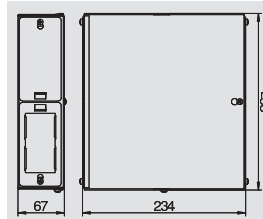

Modul 45 kandeplaat

Tüüp	Pak. tükk	kaal kg/100 tk	Art-nr.
CP45-TP M	1	4,200	6108 03 9

St teras €/tk

Kandeplaat 2 Modul 45 seadme paigaldamiseks Consolidation Point-korpusesse.

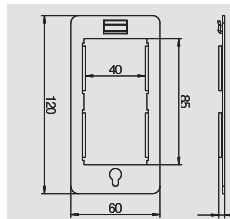

Kaabliväljundi kandeplaat

Tüüp	Pak. tükk	kaal kg/100 tk	Art-nr.
CP45-TP KE	1	8,800	6108 04 0

St teras €/tk

Kandeplaat kaablite ühendamiseks Consolidation Point-korpusesse.

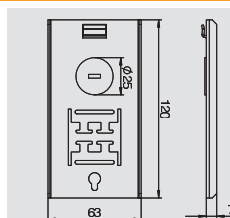

pimeplaat

Tüüp	Pak. tükk	kaal kg/100 tk	Art-nr.
CP45-BP	1	8,000	6108 04 2

St teras €/tk

Pimeplaat paigaldusava sulgemiseks Consolidation Pointi korpusel.

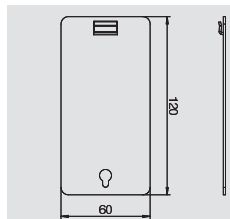

klemmliist

Tüüp	värv	Pak. tükk	kaal kg/100 tk	Art-nr.
CP45-KL	must	1	2,000	6108 04 3

€/tk

Kruvivaba vedruklemmliist tugijalaga, 5 poolusega, 0,5-4 mm² ristlõikega juhtmele.

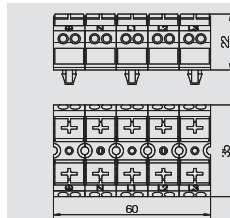

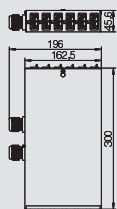
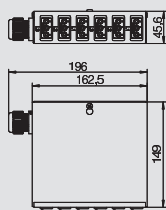
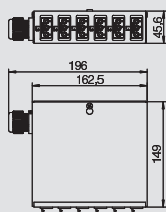

püsiühendusega energiajaotur

Tüüp	Pak.	kaal	Art-nr.
	tükk	kg/100 tk	
UVS-6W2	1	77,000	6108 00 5

St teras €/tk

Tugevoolutehnika energiajaotur, püsiühendusega, varustatud ja eeljuhtmestatud.

Sisend: 1 pöördvooluahel kruvivaba vedruklemmplokiga, 5 poolusega, juhtme ristlõikele 0,5-4 mm².
 Väljund: 6 iselukustuvat pistikühendust 3 poolusega valge, 16 A, tüüp GST18i (pesaosa: 2 x L1, 2 x L2, 2 x L3).
 Sisemine juhtmestik: PVC-juht H07V-U2,5.

Tüüp	Pak.	kaal	Art-nr.
	tükk	kg/100 tk	
UVS-6S2	1	77,000	6108 00 0

St teras €/tk

Tugevoolutehnika energiajaotur, püsiühendusega, varustatud ja eeljuhtmestatud.

Sisend: 1 pöördvooluahel kruvivaba vedruklemmplokiga, 5 poolusega, juhtme ristlõikele 0,5-4 mm².
 Väljund: 6 iselukustuvat pistikühendust 3 poolusega musta, 16 A, tüüp GST18i (pesaosa: 2 x L1, 2 x L2, 2 x L3).
 Sisemine juhtmestik: PVC-juht H07V-U2,5.

Tüüp	Pak.	kaal	Art-nr.
	tükk	kg/100 tk	
UVS-6S6W2	1	146,100	6108 01 0

St teras €/tk

Tugevoolutehnika energiajaotur, püsiühendusega, varustatud ja eeljuhtmestatud.

Sisend: 2 pöördvooluahelat kruvivaba vedruklemmplokiga, 5 poolusega, juhtme ristlõikele 0,5-4 mm².
 Väljund: 12 iselukustuvat pistikühendust 3 poolusega valge (6 x) ja must (6 x), 16 A, tüüp GST18i (pesaosa: igal pöördvooluahelal 2 x L1, 2 x L2, 2 x L3).
 Sisemine juhtmestik: PVC-juht H07V-U2,5.



pistikühendusega energiajaotur

Tüüp	Pak.	kaal	Art-nr.
	tükk	kg/100 tk	
UVS-6W2SA	1	79,000	6108 01 4

St teras €/tk

Tugevoolutehnika energiajaotur, pistikühendusega, varustatud ja eeljuhtmestatud.

Sisend: 1 pöördvooluahel iselukustuva pistikühendusega, 5 poolusega, tüüp GST18i (pistikuosa).
 Väljund: 6 iselukustuvat pistikühendust 3 poolusega valge, 16 A, tüüp GST18i (pesaosa: 2 x L1, 2 x L2, 2 x L3).
 Sisemine juhtmestik: PVC-juht H07V-U2,5.

Tüüp	Pak.	kaal	Art-nr.
	tükk	kg/100 tk	
UVS-6S2SA	1	79,000	6108 01 2

St teras €/tk

Tugevoolutehnika energiajaotur, pistikühendusega, varustatud ja eeljuhtmestatud.

Sisend: 1 pöördvooluahel iselukustuva pistikühendusega, 5 poolusega, tüüp GST18i (pistikuosa).
 Väljund: 6 iselukustuvat pistikühendust 3 poolusega musta, 16 A, tüüp GST18i (pesaosa: 2 x L1, 2 x L2, 2 x L3).
 Sisemine juhtmestik: PVC-juht H07V-U2,5.

Tüüp	Pak.	kaal	Art-nr.
	tükk	kg/100 tk	
UVS-6S6W2SA	1	140,000	6108 01 6

St teras €/tk

Tugevoolutehnika energiajaotur, pistikühendusega, varustatud ja eeljuhtmestatud.

Sisend: 2 pöördvooluahelat iselukustuva pistikühendusega, 5 poolusega, tüüp GST18i (pistikuosa).
 Väljund: 12 iselukustuvat pistikühendust 3 poolusega valge (6 x) ja must (6 x), 16 A, tüüp GST18i (pesaosa: igal pöördvooluahelal 2 x L1, 2 x L2, 2 x L3).
 Sisemine juhtmestik: PVC-juht H07V-U2,5.

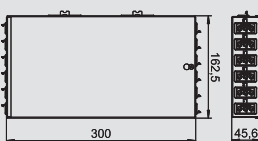
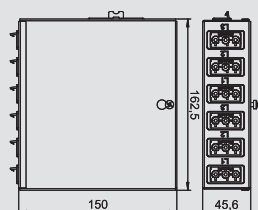
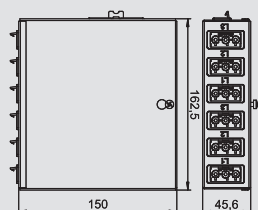



Pistik 3 poolusega, vedruklemmühendus

Tüüp	värv	Pak. tükk	kaal kg/100 tk	Art-nr.
ST-F GST18i3p SW	must	5	2,600	6108 05 0
ST-F GST18i3p W	valge	5	2,620	6108 05 1

€/tk

3 poolusega pistikuosa, tüüp GST18i vedruklemmühendusega jäikadele 1,5-2,5 mm² juhtmetele, ühekiulised ultraheliisolatsiooniga, peenekiulised juhtmed 1,5 mm², otsahülssidega, monteerimata tõmbetakistiga, kohapeal ettevalmistatav, kodeeringmust, 250 V, 16 A

2 ühendust pooluse kohta, monteerimata, juhtmetele H05VV, NYM (Ø 7,8 - 10,33 mm), lukustatav, vastavalt VDE 0628 eeskirjades eeskirjeldatud tõmbetakistile tuleb ette näha blokeering.

Katte pikkus: 45 mm
isoleerimispikkus: 9 mm

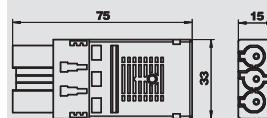

Pistik 3 poolusega, kruviühendus

Tüüp	värv	Pak. tükk	kaal kg/100 tk	Art-nr.
ST-S GST18i3p SW	must	5	2,030	6108 05 4
ST-S GST18i3p W	valge	5	2,030	6108 05 5

€/tk

3 poolusega pistikuosa, tüüp GST18i kruviühendusega, madal paigalduskõrgus (jaotuskarpidega kombineerimisel ei lähe pistikukohad kaduma), ristlõikele 0,75 - 2,5 mm², ühe- ja peenekiulised juhtmed ühendatavad otsahülssita, juhtme läbimõõdule 6,5 - 10,5 mm (H05VV, NYM), monteerimata, tõmbetakistiga, kohapeal ettevalmistatav, 250 V, 16 A.

Katte eemalduspikkus: 31 mm
Isolatsiooni eemalduspikkus: 7 mm

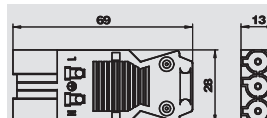

3-pooluseline pesa vedruklemmühendus

Tüüp	värv	Pak. tükk	kaal kg/100 tk	Art-nr.
BT-F GST18i3p SW	must	5	2,620	6108 05 2
BT-F GST18i3p W	valge	5	2,690	6108 05 3

€/tk

3 poolusega pesa, tüüp GST18i vedruklemmühendusega jäikadele 1,5-2,5 mm² juhtmetele, ühekiulised ultraheliisolatsiooniga, peenekiulised juhtmed 1,5 mm², otsahülssidega, monteerimata tõmbetakistiga, kohapeal ettevalmistatav, kodeeringmust, 250 V, 16 A

2 ühendust pooluse kohta, monteerimata, juhtmetele H05VV, NYM (Ø 7,8 - 10,33 mm), lukustatav, vastavalt VDE 0628 eeskirjades eeskirjeldatud tõmbetakistile tuleb ette näha blokeering.

Katte eemalduspikkus: 45 mm
isolatsiooni eemalduspikkus: 9 mm

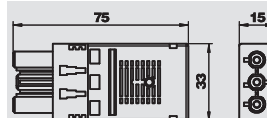

3-pooluseline pesa kruviühendus

Tüüp	värv	Pak. tükk	kaal kg/100 tk	Art-nr.
BT-S GST18i3p SW	must	5	2,150	6108 05 6
BT-S GST18i3p W	valge	5	2,150	6108 05 7

€/tk

3 poolusega pesa, tüüp GST18i kruviühendusega, madal paigalduskõrgus (jaotuskarpidega kombineerimisel ei lähe pistikukohad kaduma), ristlõikele 0,75 - 2,5 mm², ühe- ja peenekiulised juhtmed ühendatavad otsahülssita, juhtme läbimõõdule 6,5 - 10,5 mm (H05VV, NYM), monteerimata, tõmbetakistiga, kohapeal ettevalmistatav, 250 V, 16 A.

Katte eemalduspikkus: 31 mm
Isolatsiooni eemalduspikkus: 7 mm

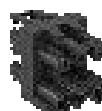
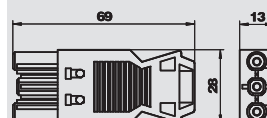

jagajablokk 3 poolusega, 1E/3A

Tüüp	värv	Pak. tükk	kaal kg/100 tk	Art-nr.
VB-3 GST18i3p	must	5	3,590	6108 08 0

€/tk

Blokeeringuga jaotusplokk, tüüp GST18i, 1 sisend, 3 poolusega pistikuosa, 3 väljundit, 3 poolusega pesaosa.

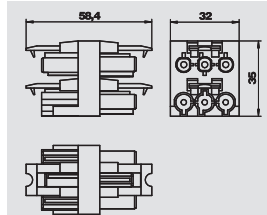

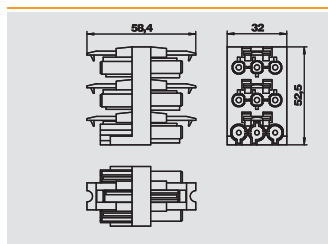

jagajablokk 3 poolusega, 1E/5A

Tüüp	värv	Pak. tükk	kaal kg/100 tk	Art-nr.
VB-5 GST18i3p	must	5	5,590	6108 08 2

€/tk

Blokeeringuga jaotusplokk, tüüp GST18i, 1 sisend, 3 poolusega pistikuosa, 5 väljundit, 3 poolusega pesaosa.

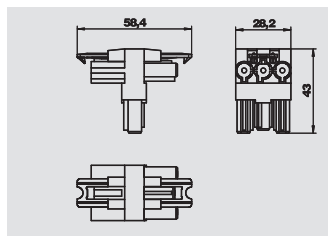

T-kujuline jagajablokk 3-poolusega

Tüüp	värv	Pak. tükk	kaal kg/100 tk	Art-nr.
VB-T GST18i3p	must	5	2,540	6108 08 4

€/tk

T-jagaja lukustusega, tüüp GST18i, 1 sisend pistikuosaga, 3 poolust ja 2 väljundit pesaga, 3 poolust.

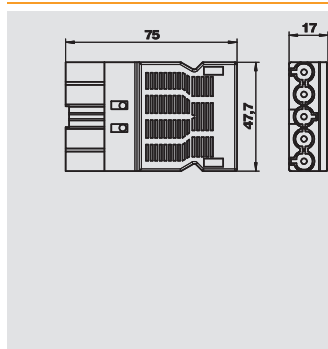

Pistik 5 poolusega, kruviühendus

Tüüp	värv	Pak. tükk	kaal kg/100 tk	Art-nr.
ST-S GST18i5p SW	must	5	4,330	6108 07 0

€/tk

5 poolusega pistikuosa, tüüp GST18i kruviühendusega, juhtmetele 1,5 - 2,5 mm², ühe- ja peenekiuline, üks ühendus pooluse kohta, monteerimata, juhtmetele H05VV (Ø 9,5 - 13,5) NYM1 (Ø 10,5 - 13,5 mm), lukustatav, vastavalt VDE 0628 eeskirjadele tõmbetakisti kohta tuleb ette näha blokeering, 250 V, 16 A

isolatsiooni eemalduspikkus: 8 mm
katte eemalduspikkus: 46 mm

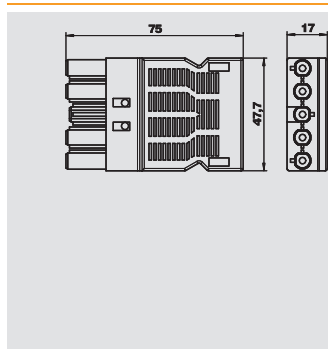

5-pooluseline pesa kruviühendus

Tüüp	värv	Pak. tükk	kaal kg/100 tk	Art-nr.
BT-S GST18i5p SW	must	5	4,550	6108 07 2

€/tk

5 poolusega pesa, tüüp GST18i kruviühendusega, juhtmetele 1,5 - 2,5 mm², ühe- ja peenekiuline, üks ühendus pooluse kohta, monteerimata, juhtmetele H05VV (Ø 9,5 - 13,5) NYM1 (Ø 10,5 - 13,5 mm), lukustatav, vastavalt VDE 0628 eeskirjadele tõmbetakisti kohta tuleb ette näha blokeering, 250 V, 16 A

isolatsiooni eemalduspikkus: 8 mm
katte eemalduspikkus: 46 mm



pikendusjuhe



3 poolusega pikendusjuhe, ristlõige 1,5 mm²

Tüüp	Juhtme pikkus mm	rist- lõige mm ²	Pooluste arv	värv	Pak. tükk	kaal kg/100 tk	Art-nr.
VL-3Q1.5 1 SW	1000	1,5	3	must	1	14,000	6108 10 0
VL-3Q1.5 2 SW	2000	1,5	3	must	1	28,000	6108 10 1
VL-3Q1.5 3 SW	3000	1,5	3	must	1	42,000	6108 10 2
VL-3Q1.5 4 SW	4000	1,5	3	must	1	56,000	6108 10 3
VL-3Q1.5 5 SW	5000	1,5	3	must	1	70,000	6108 10 4
VL-3Q1.5 6 SW	6000	1,5	3	must	1	84,000	6108 10 5
VL-3Q1.5 7 SW	7000	1,5	3	must	1	98,000	6108 10 6
VL-3Q1.5 8 SW	8000	1,5	3	must	1	112,000	6108 10 7
VL-3Q1.5 9 SW	9000	1,5	3	must	1	126,000	6108 10 8
VL-3Q1.5 10 SW	10000	1,5	3	must	1	140,000	6108 10 9
VL-3Q1.5 11 SW	11000	1,5	3	must	1	154,000	6108 11 0
VL-3Q1.5 12 SW	12000	1,5	3	must	1	168,000	6108 11 1
VL-3Q1.5 13 SW	13000	1,5	3	must	1	182,000	6108 11 2
VL-3Q1.5 14 SW	14000	1,5	3	must	1	196,000	6108 11 3
VL-3Q1.5 15 SW	15000	1,5	3	must	1	210,000	6108 11 4

€/tk

Ühendusjuhtmed 3 x 1,5 mm² pesa-pistikute teostusena GST18i-pistiküsteemidega.

Tüüp	Juhtme pikkus mm	rist- lõige mm ²	Pooluste arv	värv	Pak. tükk	kaal kg/100 tk	Art-nr.
VL-3Q1.5 1 W	1000	1,5	3	valge	1	14,000	6108 12 5
VL-3Q1.5 2 W	2000	1,5	3	valge	1	28,000	6108 12 6
VL-3Q1.5 3 W	3000	1,5	3	valge	1	42,000	6108 12 7
VL-3Q1.5 4 W	4000	1,5	3	valge	1	56,000	6108 12 8
VL-3Q1.5 5 W	5000	1,5	3	valge	1	70,000	6108 12 9
VL-3Q1.5 6 W	6000	1,5	3	valge	1	84,000	6108 13 0
VL-3Q1.5 7 W	7000	1,5	3	valge	1	98,000	6108 13 1
VL-3Q1.5 8 W	8000	1,5	3	valge	1	112,000	6108 13 2
VL-3Q1.5 9 W	9000	1,5	3	valge	1	126,000	6108 13 3
VL-3Q1.5 10 W	10000	1,5	3	valge	1	140,000	6108 13 4
VL-3Q1.5 11 W	11000	1,5	3	valge	1	154,000	6108 13 5
VL-3Q1.5 12 W	12000	1,5	3	valge	1	168,000	6108 13 6
VL-3Q1.5 13 W	13000	1,5	3	valge	1	182,000	6108 13 7
VL-3Q1.5 14 W	14000	1,5	3	valge	1	196,000	6108 13 8
VL-3Q1.5 15 W	15000	1,5	3	valge	1	210,000	6108 13 9

€/tk

Ühendusjuhtmed 3 x 1,5 mm² pesa-pistikute teostusena GST18i-pistiküsteemidega.



3 poolusega pikendusjuhe, ristlõige 2,5 mm²

Tüüp	Juhtme pikkus mm	rist- lõige mm ²	Pooluste arv	värv	Pak. tükk	kaal kg/100 tk	Art-nr.
VL-3Q2.5 1 SW	1000	2,5	3	must	1	18,000	6108 15 0
VL-3Q2.5 2 SW	2000	2,5	3	must	1	36,000	6108 15 1
VL-3Q2.5 3 SW	3000	2,5	3	must	1	54,000	6108 15 2
VL-3Q2.5 4 SW	4000	2,5	3	must	1	72,000	6108 15 3
VL-3Q2.5 5 SW	5000	2,5	3	must	1	90,000	6108 15 4
VL-3Q2.5 6 SW	6000	2,5	3	must	1	108,000	6108 15 5
VL-3Q2.5 7 SW	7000	2,5	3	must	1	126,000	6108 15 6
VL-3Q2.5 8 SW	8000	2,5	3	must	1	144,000	6108 15 7
VL-3Q2.5 9 SW	9000	2,5	3	must	1	162,000	6108 15 8
VL-3Q2.5 10 SW	10000	2,5	3	must	1	180,000	6108 15 9
VL-3Q2.5 11 SW	11000	2,5	3	must	1	198,000	6108 16 0
VL-3Q2.5 12 SW	12000	2,5	3	must	1	216,000	6108 16 1
VL-3Q2.5 13 SW	13000	2,5	3	must	1	234,000	6108 16 2
VL-3Q2.5 14 SW	14000	2,5	3	must	1	252,000	6108 16 3
VL-3Q2.5 15 SW	15000	2,5	3	must	1	270,000	6108 16 4

€/tk

Ühendusjuhtmed 3 x 2,5 mm² pesa-pistikute teostusena GST18i-pistiküsteemidega.

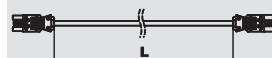
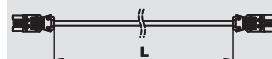

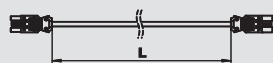

3 poolusega pikendusjuhe, ristlõige 2,5 mm²

Tüüp	Juhtme pikkus mm	ristlõige mm ²	Pooluste arv	värv	Pak. tükk	kaal kg/100 tk	Art-nr.
VL-3Q2.5 1 W	1000	2,5	3	valge	1	18,000	6108 17 5
VL-3Q2.5 2 W	2000	2,5	3	valge	1	36,000	6108 17 6
VL-3Q2.5 3 W	3000	2,5	3	valge	1	54,000	6108 17 7
VL-3Q2.5 4 W	4000	2,5	3	valge	1	72,000	6108 17 8
VL-3Q2.5 5 W	5000	2,5	3	valge	1	90,000	6108 17 9
VL-3Q2.5 6 W	6000	2,5	3	valge	1	108,000	6108 18 0
VL-3Q2.5 7 W	7000	2,5	3	valge	1	126,000	6108 18 1
VL-3Q2.5 8 W	8000	2,5	3	valge	1	144,000	6108 18 2
VL-3Q2.5 9 W	9000	2,5	3	valge	1	162,000	6108 18 3
VL-3Q2.5 10 W	10000	2,5	3	valge	1	180,000	6108 18 4
VL-3Q2.5 11 W	11000	2,5	3	valge	1	198,000	6108 18 5
VL-3Q2.5 12 W	12000	2,5	3	valge	1	216,000	6108 18 6
VL-3Q2.5 13 W	13000	2,5	3	valge	1	234,000	6108 18 7
VL-3Q2.5 14 W	14000	2,5	3	valge	1	252,000	6108 18 8
VL-3Q2.5 15 W	15000	2,5	3	valge	1	270,000	6108 18 9



€/tk

Ühendusjuhtmed 3 x 2,5 mm² pesa-pistiku teostusena GST18i-pistiküsteemidega.

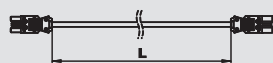

3 poolusega pikendusjuhe, halogeenivaba, ristlõige 2,5 mm²

Tüüp	Juhtme pikkus mm	ristlõige mm ²	Pooluste arv	värv	Pak. tükk	kaal kg/100 tk	Art-nr.
VL-3Q2.5 H1 SW	1000	2,5	3	must	1	16,000	6108 45 0
VL-3Q2.5 H2 SW	2000	2,5	3	must	1	32,000	6108 45 1
VL-3Q2.5 H3 SW	3000	2,5	3	must	1	48,000	6108 45 2
VL-3Q2.5 H4 SW	4000	2,5	3	must	1	64,000	6108 45 3
VL-3Q2.5 H5 SW	5000	2,5	3	must	1	80,000	6108 45 4
VL-3Q2.5 H6 SW	6000	2,5	3	must	1	96,000	6108 45 5
VL-3Q2.5 H7 SW	7000	2,5	3	must	1	112,000	6108 45 6
VL-3Q2.5 H8 SW	8000	2,5	3	must	1	128,000	6108 45 7
VL-3Q2.5 H9 SW	9000	2,5	3	must	1	144,000	6108 45 8
VL-3Q2.5 H10 SW	10000	2,5	3	must	1	160,000	6108 45 9
VL-3Q2.5 H11 SW	11000	2,5	3	must	1	176,000	6108 46 0
VL-3Q2.5 H12 SW	12000	2,5	3	must	1	192,000	6108 46 1
VL-3Q2.5 H13 SW	13000	2,5	3	must	1	208,000	6108 46 2
VL-3Q2.5 H14 SW	14000	2,5	3	must	1	224,000	6108 46 3
VL-3Q2.5 H15 SW	15000	2,5	3	must	1	240,000	6108 46 4



€/tk

Halogeenivabad pikendusjuhtmed 3 x 2,5 mm² pesa-pistiku teostusena GST18i-pistiküsteemidega.

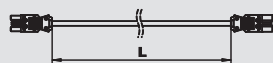

Tüüp	Juhtme pikkus mm	ristlõige mm ²	Pooluste arv	värv	Pak. tükk	kaal kg/100 tk	Art-nr.
VL-3Q2.5 H1 W	1000	2,5	3	valge	1	16,000	6108 47 5
VL-3Q2.5 H2 W	2000	2,5	3	valge	1	32,000	6108 47 6
VL-3Q2.5 H3 W	3000	2,5	3	valge	1	48,000	6108 47 7
VL-3Q2.5 H4 W	4000	2,5	3	valge	1	64,000	6108 47 8
VL-3Q2.5 H5 W	5000	2,5	3	valge	1	80,000	6108 47 9
VL-3Q2.5 H6 W	6000	2,5	3	valge	1	96,000	6108 48 0
VL-3Q2.5 H7 W	7000	2,5	3	valge	1	112,000	6108 48 1
VL-3Q2.5 H8 W	8000	2,5	3	valge	1	128,000	6108 48 2
VL-3Q2.5 H9 W	9000	2,5	3	valge	1	144,000	6108 48 3
VL-3Q2.5 H10 W	10000	2,5	3	valge	1	160,000	6108 48 4
VL-3Q2.5 H11 W	11000	2,5	3	valge	1	176,000	6108 48 5
VL-3Q2.5 H12 W	12000	2,5	3	valge	1	192,000	6108 48 6
VL-3Q2.5 H13 W	13000	2,5	3	valge	1	208,000	6108 48 7
VL-3Q2.5 H14 W	14000	2,5	3	valge	1	224,000	6108 48 8
VL-3Q2.5 H15 W	15000	2,5	3	valge	1	240,000	6108 48 9





€/tk

Halogeenivabad pikendusjuhtmed 3 x 2,5 mm² pesa-pistiku teostusena GST18i-pistiküsteemidega.





Kataloogid

	Tähestikuline sisukord	116
	numbriline loend	118
	tüübiloend	120



Tähestikuline sisukord

3

- 3 poolusega pikendusjuhe, halogeenivaba, ristlõige 2,5, 113 mm²
- 3 poolusega pikendusjuhe, ristlõige 1,5 mm², 112
- 3 poolusega pikendusjuhe, ristlõige 2,5 mm², 112-113
- 3-pooluseline pesa kruviühendus, 110
- 3-pooluseline pesa vedruklemmühendus, 110

5

- 5-pooluseline pesa kruviühendus, 111

9

- 90° pööratud lülitpaigalduse adapter, 66

A

- Andmesidepesa keskplaat 1/1 mooduliaux, 75
- Andmesidepesa keskplaat 1/2 mooduliaux, 74
- Andmesidepesa keskplaat, tüüp A, 1/1 mooduliaux, 77
- Andmesidepesa keskplaat, tüüp B, 1/1 mooduliaux, 77
- Andmesidepesa keskplaat, tüüp C, 1/1 mooduliaux, 77-78
- Andmesidepesa keskplaat, tüüp EP, 1/1 mooduliaux, 78
- Andmesidepesa keskplaat, tüüp F, 1/1 mooduliaux, 78
- Andmesidepesa keskplaat, tüüp PA, 1/1 mooduliaux, 78-79
- antennipistikupesa 1/1 mooduliaux, 70
- antennipistikupesa SAT 1/2 mooduliaux, 69

C

- CEE pistikseade, 102, 105
- CP jaotuskaabel, teostus pistik - pesa, 76

D

- Deskbox 4 Modul 45 seadmetele, 92
- Deskbox 8 Modul 45 seadmele, 92
- Deskboxi kinnituse kinnitusriba, 92

F

- Flex-kanal, 92
- Flex-kanali kleepriba, 93
- Flex-kanali põrandasiin, 93
- Flex-kanali T-hargmik, 93

H

- hoidik Flex-kanali hoidikuga, 92
- huumlambielement, 89

J

- jagajaplokk 3 poolusega, 1E/3A, 110
- jagajaplokk 3 poolusega, 1E/5A, 111
- Jaotuskaabel, teostus pistik-pistik, 76

K

- kaabliväljund 1/1 mooduliaux, 70
- Kaabliväljundi kandeplaat, 108
- kaitsekontaktiga pistikupesa 0°, 52, 101
- kaitsekontaktiga pistikupesa 33°, 52, 60, 101
- Kaitsekontaktiga pistikupesa 45° klappkaanega, IP44, 105
- Kaitseseadis VHF-8, kaas ja kandeplaat, 104
- Kaitseseadis VHF-8, kandeplaat, 105
- kandeplaadiga andmesidepesa, kat. 5e, 74
- kandeplaadiga andmesidepesa, kat. 5e, varjestatud, 74
- kandeplaadiga andmesidepesa, kat. 6, 74
- kandeplaadiga andmesidepesa, kat. 6, varjestatud 10, 74
- GbE jaoks
- kandeplaat Modul 45 fiksaatoritega, 83
- kandeplaat Modul 45 fiksaatoriteta, 83
- kandeplaat Modul 45 seadmetoosile, 1ne, 84
- kandeplaat Modul 45 seadmetoosile, 2ne, 85
- kandeplaat Modul 45 seadmetoosile, 3ne, 86
- katteplaat VH-4 / VH-8, 100-101
- katteplaat VHF-8, 103-104

K

- katteraam Modul 45, 1ne, 83
- katteraam Modul 45, 2x 1ne, 83
- katteraam Modul 45, 3x 1ne, 83
- kinnitusklemm Flex-kanalile, 92
- Kinnitusnurk Flex-kanali paigaldamiseks 10 mm GES, 94
- põrandakarpidele
- Kinnitusnurk Flex-kanali paigaldamiseks 10 mm, 94
- GESRM2 põrandakarpidele
- klemmliist, 108
- kodeerimistihvt, 55

L

- LED-element, 66
- Liigend-tolmukaitse, 75
- Liigpingekaitse moodul ÜSM-A, 56, 61
- Liigpingekaitse, 1/2 mooduliaux, akustiline signaal, 69
- Liigpingekaitse, 1/2 mooduliaux, optiline signaal, 69
- Liigpingekaitsemoodul, akustiline signaal, 69
- liikumisanduri 180° kate, 67
- LWL-ühendus kandeplaadiga, 74

M

- Maandustihvtiga pistikupesa 0°, 53, 101
- Maandustihvtiga pistikupesa 0° - kodeeritud teostus, 54
- Maandustihvtiga pistikupesa 33°, 53, 60, 101
- Maandustihvtiga pistikupesa 33° - kodeeritud teostus, 54-55
- Mehaaniline ja visuaalne sisestuskaitse, 75
- Modalneti kaitseseadise paigaldus, 88
- Modalneti katteraam Modul 45, 2ne, 88
- Modalneti katteraam Modul 45, 2x 1ne, 88
- Modalneti korpus, laiendusmoodul, 87
- Modalneti korpus, põhikonfiguratsioon, 87
- Modalneti õõnesseinapaigaldus, 2ne, 87
- Modalneti õõnesseinapaigaldus, 3ne, 87
- Modalneti õõnesseinapaigaldus, 4ne, 87-88
- Modalneti õõnesseinapaigaldus, 5ne, 88
- Modalneti õõnesseinapaigaldus, 6ne, 88
- Modul 45 kandeplaat, 108

Õ

- õõnesseina seadmetoos, 82
- õõnesseina seadmetoos Modul 45, 1ne, 84
- õõnesseina seadmetoos Modul 45, 2ne, 85
- õõnesseina seadmetoos Modul 45, 3ne, 86
- Õõnesseina topelt-seadmetoos, 82
- õõnessein-seadme-/ühenduskarp, 82

P

- pimekate 1/1 mooduliaux, 71
- pimekate 1/2 mooduliaux, 71
- pimeplaat, 108
- Pistik 3 poolusega, kruviühendus, 110
- Pistik 3 poolusega, vedruklemmühendus, 110
- Pistik 5 poolusega, kruviühendus, 111
- pistikühendusega energijaotur, 109
- Pistikupesa Šveitsi norm 0°, 55, 101
- Pistikupesa, Taani norm 0°, 55, 102
- põrandaväljavõte, T-hargmikuga, Flex-kanali jaoks, 93
- põrandaväljavõte, kandiline, Flex-kanali jaoks, 93
- põrandaväljavõte, lamelliga, Flex-kanali jaoks, 93
- põrandaväljavõte, ümmagune, Flex-kanali jaoks, 93
- Potentsiaalühtlustuspesa 1/1 mooduliaux, 70
- püsiühendusega energijaotur, 109
- Puutedimmer 1/2 mooduliaux, 67

R

- Reduktsiooniraam RJ45 teostusel RJ11/RJ12, 74
- Releesisu 1/1 mooduliaux, 67
- ristlüliti 1/1 mooduliaux, 66

R

Ruloolüliti 1/1 moodulilaius, 66
 Ruloolüliti 1/1 moodullaius, 66
 rulootaimer kate, 68
 ruumitermostaadi kate, 68

S

Safe Clip, 75
 seadmetoosi M45 katteraam Modul 45, 1ne, 84
 seadmetoosi M45 katteraam Modul 45, 2ne, 85
 seadmetoosi M45 katteraam Modul 45, 3ne, 86
 Seadmetoosi M45 signaalkaas, Modul 45, 1ne, 84
 Seadmetoosi M45 signaalkaas, Modul 45, 2ne, 85
 Seadmetoosi M45 signaalkaas, Modul 45, 3ne, 86
 Seerialüliti 1/1 moodulilaius, 66
 signaalkaas, 82
 sisselükatav kaitse RJ45 jaoks, 76
 sõlmkett, 100, 103
 süvistatav seadme-/ühendustoos, 82
 Süvistatav seadmetoos, 82
 Süvistatav seadmetoos odul 45, 1ne, 84
 Süvistatav seadmetoos odul 45, 2ne, 85
 Süvistatav seadmetoos odul 45, 3ne, 86

T

taimer kate, 68
 Telefonipesa 1/1 moodulilaius, 70
 T-kujuline jagajablokk 3-poolusega, 111
 tõmbetakisti, 55, 61
 tõmbevedru VH-4 / VH-8, 100
 tõmbevedru VHF-8, 103
 tühi korpus, 108

Ü

ühendus- ja iidedekaitse, 75
 Ühendus- ja iidedekaitse võti, 76
 ühendusadapter, 61
 ühendusadapter sirge, pesaosa, 60
 ühendusadapter sirge, pistikuosa, 60

U

U-kujuline ühendusadapter, pistikuosa, 61

V

Vahesein VH-4, 100
 Vahesein VH-8, 100
 Vahesein VHF8 suruõhuühendusega, 103
 Vahesein VHF8 suruõhuühendusega, 103
 väljalüliti 1/1 moodulilaius, 65
 väljalüliti 1/2 moodulilaius, 64
 Veksellüliti 1/1 moodulilaius, 64-65
 Veksellüliti 1/2 moodulilaius, 64-65
 VH-4 toiteüksus suruõhuühendusega, IP20, 98-99
 VH-4 toiteüksus, IP20, 98
 VH-8 toiteüksus suruõhuühendusega, IP20, 99
 VH-8 toiteüksus, IP20, 99
 VHF-8 toiteüksus, IP44, 103
 VHF-8 toiteüksus, IP44 suruõhuühendusega, 103

numbriline loend

EAN-koodi struktuur: riigi tähis **40** tootja tähis **1219** (artiklinumbrid. kui alguses on **0: 1010**) Individuaalne EAN-C **5647589**

EAN-C.	Art-nr.	hind	lehek	EAN-C.	Art-nr.	hind	lehek	EAN-C.	Art-nr.	hind	lehek	EAN-C.	Art-nr.	hind	lehek
		€/100 tk				€/tk				€/tk				€/tk	
5000204	2003 01 5		82	5122517	6108 11 0		112	5124962	6108 48 9		113	6597376	6117 02 9		52
5002314	2003 01 9		82	5122524	6108 11 1		112					5700890	6117 03 0		52
5029298	2003 31 7		82	5122562	6108 11 2		112	5125037	6109 80 0		98	6213078	6117 03 1		52
5032779	2003 41 4		82	5122579	6108 11 3		112	5125044	6109 80 2		98	6459018	6117 04 1		52
5032830	2003 42 2		82	5122586	6108 11 4		112	5125075	6109 80 4		98	6459070	6117 04 3		52
5032953	2003 44 2		82	5122692	6108 12 5		112	5125082	6109 80 6		98	6459131	6117 04 5		52
				5122708	6108 12 6		112	5125099	6109 80 8		98	6459377	6117 04 7		52
				5122746	6108 12 7		112	5125105	6109 81 0		98	5700906	6117 04 8		52
				5122753	6108 12 8		112	5125136	6109 81 2		98	6213139	6117 04 9		52
5080886	5092 45 1	€/tk	56	5122760	6108 12 9		112	5125143	6109 81 4		99	6459551	6117 05 2		52
				5122807	6108 13 0		112	5125150	6109 81 6		99	6459612	6117 05 4		52
				5122814	6108 13 1		112	5125167	6109 81 8		99	6459674	6117 05 6		52
5364139	6106 67 1		54	5122821	6108 13 2		112	5125198	6109 82 0		99	6459735	6117 05 8		52
5364146	6106 67 3		54	5122869	6108 13 3		112	5287391	6109 82 1		99	5700913	6117 05 9		52
5364177	6106 67 5		54	5122876	6108 13 4		112	5125204	6109 82 2		103	6213191	6117 06 0		52
5364184	6106 67 7		54	5122883	6108 13 5		112	5125211	6109 82 5		99	6459797	6117 06 3		52
5364191	6106 67 9		54	5122920	6108 13 6		112	5125228	6109 82 7		103	6459858	6117 06 5		52
5364207	6106 68 1		54	5122937	6108 13 7		112	5125259	6109 83 0		103	6459971	6117 06 7		52
5364238	6106 68 3		54	5122944	6108 13 8		112	5287407	6109 83 1		100	6460038	6117 06 9		52
5364245	6106 68 5		54	5122982	6108 13 9		112	5125266	6109 83 2		100	5700920	6117 07 0		52
5364252	6106 68 7		54	5123064	6108 15 0		112	5125273	6109 83 4		100	6213436	6117 07 1		52
5364269	6106 68 9		54	5123101	6108 15 1		112	5125280	6109 83 6		100	5437925	6117 07 4		60
5364306	6106 69 1		54	5123118	6108 15 2		112	5125310	6109 83 8		101	5437932	6117 07 6		60
5364313	6106 69 3		54	5123125	6108 15 3		112	5428459	6109 83 9		100	5437949	6117 07 8		60
5364320	6106 69 5		54	5123163	6108 15 4		112	5125327	6109 84 0		100	5437970	6117 08 0		60
5364368	6106 69 7		54	5123170	6108 15 5		112	5125334	6109 84 2		101	5700937	6117 08 1		60
5364375	6106 69 9		54	5123187	6108 15 6		112	5125341	6109 85 0		104	5437987	6117 08 2		60
5364382	6106 70 1		54	5123224	6108 15 7		112	5125372	6109 85 2		105	6460090	6117 10 2		53
5364412	6106 70 3		54	5123231	6108 15 8		112	5125389	6109 85 4		105	6460151	6117 10 4		53
5364429	6106 70 5		54	5123248	6108 15 9		112	5125396	6109 86 0		103	6460212	6117 10 6		53
5364436	6106 70 7		54	5123286	6108 16 0		112	5125402	6109 86 1		103	6460274	6117 10 8		53
5364443	6106 70 9		54	5123293	6108 16 1		112	5125440	6109 86 2		100	5700944	6117 10 9		53
5364474	6106 71 1		54	5123309	6108 16 2		112	5125457	6109 86 3		103	6213498	6117 11 0		53
5364481	6106 71 3		54	5123347	6108 16 3		112	5125464	6109 86 4		104	6460335	6117 11 1		53
5364498	6106 71 5		54	5123354	6108 16 4		112	5125501	6109 86 5		104	6460458	6117 11 3		53
5364504	6106 71 7		54	5123422	6108 17 5		113	5125518	6109 86 6		104	6188956	6117 11 5		53
5364535	6106 71 9		54	5123453	6108 17 6		113	5125525	6109 86 7		104	6189014	6117 11 7		53
5364542	6106 72 1		55	5123460	6108 17 7		113	5125532	6109 86 8		104	5433552	6117 11 8		53
5364559	6106 72 3		55	5123477	6108 17 8		113			€/m		6213559	6117 11 9		53
5364566	6106 72 5		55	5123484	6108 17 9		113	5125549	6109 87 0		100	6189076	6117 12 3		53
5364597	6106 72 7		55	5123514	6108 18 0		113			€/tk		6189311	6117 12 5		53
5364603	6106 72 9		55	5123521	6108 18 1		113	5125556	6109 87 2		105	6189373	6117 12 7		53
5364610	6106 73 5		55	5123538	6108 18 2		113	5125594	6109 87 4		102	6189618	6117 12 9		53
				5123545	6108 18 3		113	5125600	6109 87 6		102	5433569	6117 13 0		53
				5123552	6108 18 4		113	5477440	6109 87 8		104	6213795	6117 13 1		53
5122265	6108 00 0		109	5123569	6108 18 5		113	5477457	6109 87 9		104	6189793	6117 14 0		53
5122272	6108 00 5		109	5123576	6108 18 6		113					6189854	6117 14 2		53
5122289	6108 01 0		109	5123590	6108 18 7		113	5125730	6109 90 0		87	6287291	6117 14 4		53
5522997	6108 01 2		109	5123606	6108 18 8		113	5125747	6109 90 5		87	6287536	6117 14 6		53
5523000	6108 01 4		109	5123613	6108 18 9		113	5670360	6109 90 9		87	5700968	6117 14 7		53
5523017	6108 01 6		109	5124368	6108 45 0		113	5670384	6109 92 4		88	6213856	6117 14 8		53
5577942	6108 03 7		108	5124375	6108 45 1		113	5670414	6109 92 7		88	6460632	6117 15 1		53
5577959	6108 03 9		108	5124382	6108 45 2		113	5125815	6109 93 2		88	6538690	6117 15 3		53
5577966	6108 04 0		108	5124429	6108 45 3		113	5125822	6109 93 4		87	6637218	6117 15 5		53
5577973	6108 04 2		108	5124436	6108 45 4		113	5125860	6109 93 6		87	6461059	6117 15 7		53
5577980	6108 04 3		108	5124443	6108 45 5		113	5125877	6109 93 8		88	5700975	6117 15 8		53
5273530	6108 05 0		110	5124481	6108 45 6		113	5125884	6109 94 0		88	6213917	6117 15 9		53
5273547	6108 05 1		110	5124498	6108 45 7		113	5125921	6109 94 2		88	6461110	6117 16 2		53
5273585	6108 05 2		110	5124504	6108 45 8		113	5125938	6109 95 0		87	6461233	6117 16 4		53
5273592	6108 05 3		110	5124542	6108 45 9		113	5125945	6109 95 2		87	6461356	6117 16 6		53
5273608	6108 05 4		110	5124559	6108 46 0		113	5125983	6109 95 4		87	6461530	6117 16 8		53
5273646	6108 05 5		110	5124566	6108 46 1		113	5125990	6109 95 6		88	5700982	6117 16 9		53
5273653	6108 05 6		110	5124603	6108 46 2		113	5126003	6109 95 8		88	6213979	6117 17 0		53
5273660	6108 05 7		110	5124610	6108 46 3		113					5438069	6117 19 0		60
5273707	6108 07 0		111	5124627	6108 46 4		113	6458295	6117 00 1		52	5483540	6117 19 1		60
5273714	6108 07 2		111	5124733	6108 47 5		113	6458356	6117 00 3		52	5438090	6117 19 2		60
5273721	6108 08 0		110	5124740	6108 47 6		113	6458530	6117 00 5		52	5483571	6117 19 3		60
5273769	6108 08 2		111	5124788	6108 47 7		113	6458592	6117 00 7		52	5670933	6117 19 6		61
5273776	6108 08 4		111	5124795	6108 47 8		113	5700883	6117 00 8		52	5670940	6117 19 7		61
5122326	6108 10 0		112	5124801	6108 47 9		113	6212774	6117 00 9		52	5438113	6117 19 8		61
5122333	6108 10 1		112	5124832	6108 48 0		113	6518531</							

EAN-C.	Art-nr.	hind	lehek	EAN-C.	Art-nr.	hind	lehek	EAN-C.	Art-nr.	hind	lehek	EAN-C.	Art-nr.	hind	lehek
		€/tk				€/tk				€/tk				€/tk	
5006725	6117 29 3		74	5701019	6117 62 2		64	5677819	6117 97 2		74	5406426	6119 96 6		84
				5701026	6117 62 3		64	5677765	6117 98 0		89	5406433	6119 96 8		84
5701194	6117 31 4		75	5275695	6117 62 4		64	5677864	6117 98 5		70	5701392	6119 96 9		84
				5275701	6117 62 5		64	5677871	6117 98 6		70	5406440	6119 97 0		84
5006848	6117 31 5		75	5701033	6117 62 6		65	5677888	6117 98 7		70	5406471	6119 97 2		85
5006886	6117 31 6		75	5275749	6117 62 7		65					5701408	6119 97 3		85
				5275756	6117 62 8		65	5696896	6119 20 2		77	5406488	6119 97 4		85
5701200	6117 31 8		75	5701040	6117 62 9		65	5696902	6119 20 4		77	5406495	6119 97 6		86
				5275763	6117 63 0		65	5696940	6119 20 6		77	5701439	6119 97 7		86
5006947	6117 31 9		75	5275800	6117 63 1		65	5696957	6119 20 8		77	5406501	6119 97 8		86
5006961	6117 32 0		75	5701057	6117 63 3		65	5696964	6119 21 0		77	5438236	6119 98 2		83
6235155	6117 32 5		74	5275817	6117 63 4		65	5696971	6119 21 2		77	5701446	6119 98 3		83
6235216	6117 32 9		74	5285953	6117 63 6		65	5696988	6119 21 4		77	5438243	6119 98 4		83
6235278	6117 33 7		74	5405924	6117 63 7		66	5696995	6119 21 6		77	5438274	6119 98 6		83
6235339	6117 34 1		74	5405931	6117 63 8		66	5697008	6119 21 8		77	5701453	6119 98 7		83
				5701064	6117 63 9		66	5697015	6119 22 0		78	5438281	6119 98 8		83
5443674	6117 35 2		68	5275824	6117 64 0		65	5697022	6119 22 2		78	5523031	6119 99 0		83
5443681	6117 35 4		68	5275862	6117 64 1		65	5697039	6119 22 4		78	5523048	6119 99 1		83
5701217	6117 35 6		68	5701071	6117 64 2		65	5697046	6119 22 6		78	5701460	6119 99 2		83
5443698	6117 35 8		68	5701088	6117 64 3		65	5697053	6119 22 8		78	5523055	6119 99 4		83
5443742	6117 36 0		68	5275879	6117 64 4		65	5697060	6119 23 0		78	5523062	6119 99 5		83
5701224	6117 36 2		68	5275886	6117 64 5		65	5697077	6119 23 2		78	5701491	6119 99 6		83
5443759	6117 36 4		68	5701095	6117 64 6		65	5697084	6119 23 4		78	5701507	6119 99 7		70
5443766	6117 36 6		68	5275923	6117 64 7		65	5697121	6119 23 6		78	5406532	6119 99 8		70
5701255	6117 36 8		68	5275930	6117 64 8		65	5697138	6119 23 8		77	5406549	6119 99 9		70
5443797	6117 37 0		67	5701101	6117 64 9		65	5697145	6119 24 0		77				
5443803	6117 37 2		67	5275947	6117 65 0		65	5697183	6119 24 2		77				
5701262	6117 37 4		67	5275985	6117 65 1		65	5697190	6119 24 4		77			€/m	
5675112	6117 38 1		70	5701132	6117 65 3		66	5697206	6119 24 6		77	6277339	6154 92 0		92
5675129	6117 38 3		70	5275992	6117 65 4		66	5697244	6119 24 8		77	6277575	6154 92 2		92
5675150	6117 38 5		70	5276005	6117 65 5		66	5697251	6119 25 0		78	6277759	6154 92 4		92
5675167	6117 38 7		70	5701149	6117 65 6		66					6277995	6154 93 0		92
5675174	6117 38 9		70	5405948	6117 65 7		66	5697268	6119 25 2		78			€/tk	
5675181	6117 39 1		70	5405955	6117 65 8		66					6278350	6154 96 1		92
5675211	6117 39 3		70	5443704	6117 66 2		67	5697305	6119 25 4		78	6278411	6154 96 5		93
5675228	6117 39 5		70	5443735	6117 66 5		67	5697381	6119 26 2		79	6278473	6154 96 8		92
5675235	6117 39 7		70	5701156	6117 66 8		64	5697428	6119 26 4		79	6278534	6154 97 1		93
6117499	6117 40 6		71	5701323	6117 66 9		64	5697435	6119 26 6		79	6278596	6154 97 5		93
5701279	6117 40 7		71	5276043	6117 67 0		64	5697442	6119 26 8		78	6278657	6154 98 0		93
6214037	6117 40 8		71	5276050	6117 67 1		64	5697480	6119 27 0		78	6278718	6154 98 3		93
6117550	6117 41 4		71	5701330	6117 67 2		64	5697497	6119 27 2		78	5081036	6154 99 0		93
5701286	6117 41 5		71	5623809	6117 67 3		64					5081043	6154 99 2		93
6215652	6117 41 6		71	5623816	6117 67 4		64	5670865	6119 85 0		60	5081050	6154 99 4		93
6215713	6117 42 8		70	5276067	6117 67 5		64	5670872	6119 85 2		60				
6215959	6117 43 0		70	5276104	6117 67 6		64	5670889	6119 85 4		60				
6117611	6117 46 5		69	5701347	6117 67 7		64	5670896	6119 85 6		60	5469148	6258 14 1		66
5006220	6117 46 7		69	5405962	6117 67 8		64	5670902	6119 85 8		60				
6117673	6117 47 3		69	5405993	6117 67 9		64	5670919	6119 86 0		60				
5006213	6117 47 5		69					5670926	6119 86 8		60	5437154	7407 86 0		94
				6237913	6117 70 8		75	5670957	6119 87 0		60	5437161	7407 86 2		94
5007203	6117 51 0		92	6239054	6117 72 4		75	5670964	6119 87 2		60	5437192	7407 86 4		94
6237432	6117 51 1		92	6239351	6117 72 6		75	5670971	6119 87 4		60				
5007241	6117 51 2		92	6239474	6117 72 8		75	5670988	6119 87 6		60				
5007302	6117 51 4		92	6239535	6117 73 2		76	5670995	6119 87 8		60				
5007326	6117 51 6		92	6239597	6117 73 6		75	5671008	6119 88 0		60				
5007364	6117 52 1		92	5007562	6117 73 7		75	5671015	6119 88 2		60				
6237739	6117 52 2		92	5007609	6117 73 8		75	5671022	6119 88 4		60				
5007425	6117 52 3		92	6237319	6117 74 0		74	5671039	6119 88 6		60				
5007449	6117 52 5		92	6239658	6117 74 5		76	5671046	6119 88 8		60				
5007487	6117 52 7		92					5671084	6119 89 0		60				
5007548	6117 53 8		92	5276234	6117 75 7		66	5438229	6119 93 4		83				
5675242	6117 54 0		67	5276241	6117 75 8		66	5523024	6119 93 6		83				
5675273	6117 54 2		67					5406075	6119 94 0		84				
5675280	6117 54 4		67	5081005	6117 93 8		76	5406082	6119 94 1		85				
5675297	6117 54 8		67	5008521	6117 94 0		76	5406112	6119 94 3		86				
5675303	6117 55 0		67	5008569	6117 94 2		76	5406266	6119 94 5		84				
5675341	6117 55 2		67	5008620	6117 94 4		76	5406297	6119 94 6		85				
				5081401	6117 94 6		76	5406303	6119 94 7		86				
5406204	6117 60 6		69	5008644	6117 94 8		76	5406310	6119 95 0		84				
5406235	6117 60 7		69	5008682	6117 95 0		76	5406327	6119 95 1		85				
5701316	6117 61 0		69	5008743	6117 95 2		76	5406334	6119 95 2		86				
5700999	6117 61 4		66	5008767	6117 95 7		75	5406341	6119 95 5		84				
5405887	6117 61 5		66	5008804	6117 95 8		75	5406358	6119 95 6		85				
5405894	6117 61 6		66	5402466	6117 96 0		76	5406365	6119 95 7		86				
5405900	6117 61 7		64	5402473	6117 96 2		76	5406372	6119 96 0		84				
5405917	6117 61 8		64	5402480	6117 96 4		76	5701378	6119 96 1		84				
5701002	6117 61 9		64	5402527	6117 96 6		76	5406389	6119 96 2		84				
5275640	6117 62 0		64	5402534	6117 96 8		76	5406419	6119 96 4		84				
5275688	6117 62 1		64	5402541	6117 97 0		76	5701385	6119 96 5		84				

tüübiloend

EAN-koodi struktuur: riigi tähis 40 tootja tähis 1219 (artiklinumbrid, kui alguses on 0: 1010) Individuaalne EAN-C 5647589

Tüüp	Mõõtmed/värv/er.	EAN-C.	Art-nr.	hind	lehekül	Tüüp	Mõõtmed/värv/er.	EAN-C.	Art-nr.	hind	lehekül
				€/tk						€/tk	
AD-90G M45	/ St	5469148	6258 14 1		66	BE-GL B10R	oranž	5677765	6117 98 0		89
ADP-B AL0.5	alumiiniumvärvi	6215652	6117 41 6		71						
ADP-B AL1	alumiiniumvärvi	6214037	6117 40 8		71	BE-LED B1GN	roheline	5276241	6117 75 8		66
ADP-B RW0.5	polaarvalge	6117550	6117 41 4		71	BE-LED B1RO	punane	5276234	6117 75 7		66
ADP-B RW1	polaarvalge	6117499	6117 40 6		71						
ADP-B SWGR0.5	mustjashall	5701286	6117 41 5		71	BM-A180 AL1	alumiiniumvärvi	5443803	6117 37 2		67
ADP-B SWGR1	mustjashall	5701279	6117 40 7		71	BM-A180 RW1	polaarvalge	5443797	6117 37 0		67
						BM-A180 SWGR1	mustjashall	5701262	6117 37 4		67
ADR-UP80M0.5 AL	alumiiniumvärvi	5438243	6119 98 4		83						
ADR-UP80M0.5 RW	polaarvalge	5438236	6119 98 2		83	BTA-SKS S1 SW	must	5438069	6117 19 0		60
ADR-UP80M0.5SWGR	mustjashall	5701446	6119 98 3		83	BTA-SKS S1 W	valge	5483540	6117 19 1		60
ADR-UP80M1 AL	alumiiniumvärvi	5438281	6119 98 8		83						
ADR-UP80M1 RW	polaarvalge	5438274	6119 98 6		83						
ADR-UP80M1 SWGR	mustjashall	5701453	6119 98 7		83	BT-F GST18i3p SW	must	5273585	6108 05 2		110
ADR-UP80M2 AL	alumiiniumvärvi	5523048	6119 99 1		83	BT-F GST18i3p W	valge	5273592	6108 05 3		110
ADR-UP80M2 RW	polaarvalge	5523031	6119 99 0		83						
ADR-UP80M2 SWGR	mustjashall	5701460	6119 99 2		83	BT-S GST18i3p SW	must	5273653	6108 05 6		110
ADR-UP80M3 AL	alumiiniumvärvi	5523062	6119 99 5		83	BT-S GST18i3p W	valge	5273660	6108 05 7		110
ADR-UP80M3 RW	polaarvalge	5523055	6119 99 4		83	BT-S GST18i5p SW	must	5273714	6108 07 2		111
ADR-UP80M3 SWGR	mustjashall	5701491	6119 99 6		83						
ADR-UPM0.5 AL	alumiiniumvärvi	5406389	6119 96 2		84	CEE-16A		5125594	6109 87 4		102
ADR-UPM0.5 RW	polaarvalge	5406372	6119 96 0		84	CEE-16A		5125594	6109 87 4		105
ADR-UPM0.5 SWGR	mustjashall	5701378	6119 96 1		84	CEE-32A		5125600	6109 87 6		102
ADR-UPM1 AL	alumiiniumvärvi	5406426	6119 96 6		84	CEE-32A		5125600	6109 87 6		105
ADR-UPM1 RW	polaarvalge	5406419	6119 96 4		84						
ADR-UPM1 SWGR	mustjashall	5701385	6119 96 5		84	CP45-BP	/ St	5577973	6108 04 2		108
ADR-UPM1.5 AL	alumiiniumvärvi	5406440	6119 97 0		84	CP45-KL	must	5577980	6108 04 3		108
ADR-UPM1.5 RW	polaarvalge	5406433	6119 96 8		84	CP45-LG 8A	/ St	5577942	6108 03 7		108
ADR-UPM1.5 SWGR	mustjashall	5701392	6119 96 9		84	CP45-LP KE	/ St	5577966	6108 04 0		108
ADR-UPM2 AL	alumiiniumvärvi	5406488	6119 97 4		85	CP45-TP M	/ St	5577959	6108 03 9		108
ADR-UPM2 RW	polaarvalge	5406471	6119 97 2		85						
ADR-UPM2 SWGR	mustjashall	5701408	6119 97 3		85	CPK-C5SF UTP10	hall	5008569	6117 94 2		76
ADR-UPM3 AL	alumiiniumvärvi	5406501	6119 97 8		86	CPK-C5SF UTP15	hall	5008620	6117 94 4		76
ADR-UPM3 RW	polaarvalge	5406495	6119 97 6		86	CPK-C5SF UTP2	hall	5081005	6117 93 8		76
ADR-UPM3 SWGR	mustjashall	5701439	6119 97 7		86	CPK-C5SF UTP7.5	hall	5008521	6117 94 0		76
						CPK-C6S FTP10	hall	5008682	6117 95 0		76
ANT-1S AL0.5	alumiiniumvärvi	5406235	6117 60 7		69	CPK-C6S FTP15	hall	5008743	6117 95 2		76
ANT-1S RW0.5	polaarvalge	5406204	6117 60 6		69	CPK-C6S FTP2	hall	5081401	6117 94 6		76
ANT-1S SWGR0.5	mustjashall	5701316	6117 61 0		69	CPK-C6S FTP7.5	hall	5008644	6117 94 8		76
ANT-2D AL1	alumiiniumvärvi	5675181	6117 39 1		70						
ANT-2D RW1	polaarvalge	5675167	6117 38 7		70						
ANT-2D SWGR1	mustjashall	5675174	6117 38 9		70	CST-SKS	must/ PC	5364610	6106 73 5		55
ANT-2E AL1	alumiiniumvärvi	5675150	6117 38 5		70						
ANT-2E RW1	polaarvalge	5675112	6117 38 1		70						
ANT-2E SWGR1	mustjashall	5675129	6117 38 3		70	DMG-1RM AL0.5	alumiiniumvärvi	5006725	6117 29 3		74
ANT-3E AL1	alumiiniumvärvi	5675235	6117 39 7		70	DMG-1RM RW0.5	polaarvalge	6233410	6117 29 2		74
ANT-3E RW1	polaarvalge	5675211	6117 39 3		70						
ANT-3E SWGR1	mustjashall	5675228	6117 39 5		70	DMG-1RM SWGR0.5	mustjashall	5701163	6117 29 1		74
AS-B AL0.5	alumiiniumvärvi	5275688	6117 62 1		64	DMG-2RM AL1	alumiiniumvärvi	5006961	6117 32 0		75
AS-B RW0.5	polaarvalge	5275640	6117 62 0		64	DMG-2RM RW1	polaarvalge	5006947	6117 31 9		75
AS-B SWGR0.5	mustjashall	5701019	6117 62 2		64						
AS-B2P AL1	alumiiniumvärvi	5275886	6117 64 5		65	DMG-2RM SWGR1	mustjashall	5701200	6117 31 8		75
AS-B2P RW1	polaarvalge	5275879	6117 64 4		65						
AS-B2P SWGR1	mustjashall	5701088	6117 64 3		65						
AS-K AL0.5	alumiiniumvärvi	5275701	6117 62 5		64	DMS-2RM AL1	alumiiniumvärvi/ PC	5006886	6117 31 6		75
AS-K RW0.5	polaarvalge	5275695	6117 62 4		64	DMS-2RM RW1	polaarvalge/ PC	5006848	6117 31 5		75
AS-K SWGR0.5	mustjashall	5701026	6117 62 3		64	DMS-2RM SWGR1	mustjashall/ PC	5701194	6117 31 4		75
AS-K2P AL1	alumiiniumvärvi	5275930	6117 64 8		65						
AS-K2P RW1	polaarvalge	5275923	6117 64 7		65						
AS-K2P SWGR1	mustjashall	5701095	6117 64 6		65	DMZ-AVS GN	roheline	6239054	6117 72 4		75
						DMZ-AVS RO	punane	6239351	6117 72 6		75
						DMZ-AVS W	valge	6239474	6117 72 8		75
ASM-C5		6235278	6117 33 7		74	DMZ-ES AVS	must	6239658	6117 74 5		76
ASM-C5 G		6235155	6117 32 5		74	DMZ-ESMV CB	valge	6237913	6117 70 8		75
ASM-C6		6235339	6117 34 1		74	DMZ-RR RJ11	roheline	5677819	6117 97 2		74
ASM-C6 G		6235216	6117 32 9		74	DMZ-SC GN	roheline	5008767	6117 95 7		75
ASM-LWL K		6237319	6117 74 0		74	DMZ-SC RO	punane	5008804	6117 95 8		75
						DMZ-SCHL AVS	kollane	6239535	6117 73 2		76
						DMZ-STS GN	roheline	5007562	6117 73 7		75
AS-NA AL0.5	alumiiniumvärvi	5405917	6117 61 8		64	DMZ-STS RO	punane	5007609	6117 73 8		75
AS-NA RW0.5	polaarvalge	5405900	6117 61 7		64	DMZ-STS W	valge	6239597	6117 73 6		75
AS-NA SWGR0.5	mustjashall	5701002	6117 61 9		64						
AS-NA2P AL1	alumiiniumvärvi	5275985	6117 65 1		65	DSK-KLB	/ PVC	5007548	6117 53 8		92
AS-NA2P RW1	polaarvalge	5275947	6117 65 0		65	DSK-LG4M AL	alumiiniumvärvi/ PVC	5007326	6117 51 6		92
AS-NA2P SWGR1	mustjashall	5701101	6117 64 9		65	DSK-LG4M ATHGR	antratsiithall/ PVC	5007302	6117 51 4		92
						DSK-LG4M BL	sinine/ PVC	6237432	6117 51 1		92
						DSK-LG4M LGR	helehall/ PVC	5007241	6117 51 2		92
BAL-FLK E	antratsiithall	5081043	6154 99 2		93	DSK-LG4M RW	polaarvalge/ PVC	5007203	6117 51 0		92
BAL-FLK R	antratsiithall	5081036	6154 99 0		93	DSK-LG8M AL	alumiiniumvärvi/ PVC	5007487	6117 52 7		92
BAL-FLK TAZ	antratsiithall/ PVC	6278596	6154 97 5		93	DSK-LG8M ATHGR	antratsiithall/ PVC	5007449	6117 52 5		92
BAL-L	antratsiithall	5081050	6154 99 4		93	DSK-LG8M BL	sinine/ PVC	6237739	6117 52 2		92
						DSK-LG8M LGR	helehall/ PVC	5007425	6117 52 3		92
						DSK-LG8M RW	polaarvalge/ PVC	5007364	6117 52 1		92

Tüüp	Mõõtmed/värv/er.	EAN-C.	Art-nr.	hind	lehekül	Tüüp	Mõõtmed/värv/er.	EAN-C.	Art-nr.	hind	lehekül
DTG-2A AL1	alumiiniumvärvi/ PC	5696940	6119 20 6	€/tk	77	PD-UPM1	punane	5406266	6119 94 5	€/tk	84
DTG-2A RW1	polaarvalge/ PC	5696896	6119 20 2		77	PD-UPM2	punane	5406297	6119 94 6		85
DTG-2A SWGR1	mustjashall/ PC	5696902	6119 20 4		77	PD-UPM3	punane	5406303	6119 94 7		86
DTG-2B AL1	alumiiniumvärvi/ PC	5696971	6119 21 2		77						
DTG-2B RW1	polaarvalge/ PC	5696957	6119 20 8		77	RE-U2K 1		5443735	6117 66 5		67
DTG-2B SWGR1	mustjashall/ PC	5696964	6119 21 0		77	RE-UW 1		5443704	6117 66 2		67
DTG-2C AL1	alumiiniumvärvi/ PC	5697008	6119 21 8		77						
DTG-2C RW1	polaarvalge/ PC	5696988	6119 21 4		77						
DTG-2C SWGR1	mustjashall/ PC	5696995	6119 21 6		77	RK-C5SF UTP1	hall	5402466	6117 96 0		76
DTG-2EP AL1	alumiiniumvärvi/ PC	5697121	6119 23 6		78	RK-C5SF UTP3	hall	5402473	6117 96 2		76
DTG-2EP RW1	polaarvalge/ PC	5697077	6119 23 2		78	RK-C5SF UTP5	hall	5402480	6117 96 4		76
DTG-2EP SWGR1	mustjashall/ PC	5697084	6119 23 4		78	RK-C6S FTP1	hall	5402527	6117 96 6		76
DTG-2F AL1	alumiiniumvärvi/ PC	5697039	6119 22 4		78	RK-C6S FTP3	hall	5402534	6117 96 8		76
DTG-2F RW1	polaarvalge/ PC	5697015	6119 22 0		78	RK-C6S FTP5	hall	5402541	6117 97 0		76
DTG-2F SWGR1	mustjashall/ PC	5697022	6119 22 2		78						
DTG-2PA AL1	alumiiniumvärvi/ PC	5697060	6119 23 0		78						
DTG-2PA RW1	polaarvalge/ PC	5697046	6119 22 6		78	RS-BS1 AL1	alumiiniumvärvi	5276005	6117 65 5		66
DTG-2PA SWGR1	mustjashall/ PC	5697053	6119 22 8		78	RS-BS1 RW1	polaarvalge	5275992	6117 65 4		66
						RS-BS1 SWGR1	mustjashall	5701132	6117 65 3		66
DTS-2A AL1	alumiiniumvärvi/ PC	5697183	6119 24 2		77						
DTS-2A RW1	polaarvalge/ PC	5697138	6119 23 8		77	RT-BS1 AL1	alumiiniumvärvi	5405955	6117 65 8		66
DTS-2A SWGR1	mustjashall/ PC	5697145	6119 24 0		77	RT-BS1 RW1	polaarvalge	5405948	6117 65 7		66
DTS-2B AL1	alumiiniumvärvi/ PC	5697244	6119 24 8		77	RT-BS1 SWGR1	mustjashall	5701149	6117 65 6		66
DTS-2B RW1	polaarvalge/ PC	5697190	6119 24 4		77						
DTS-2B SWGR1	mustjashall/ PC	5697206	6119 24 6		77	RTR-A AL1	alumiiniumvärvi	5443742	6117 36 0		68
DTS-2C AL1	alumiiniumvärvi/ PC	5697305	6119 25 4		78	RTR-A RW1	polaarvalge	5443698	6117 35 8		68
DTS-2C RW1	polaarvalge/ PC	5697251	6119 25 0		78	RTR-A SWGR1	mustjashall	5701224	6117 36 2		68
DTS-2C SWGR1	mustjashall/ PC	5697268	6119 25 2		78	RZU-A AL 1	alumiiniumvärvi	5443766	6117 36 6		68
DTS-2EP AL1	alumiiniumvärvi/ PC	5697497	6119 27 2		78	RZU-A RW1	polaarvalge	5443759	6117 36 4		68
DTS-2EP RW1	polaarvalge/ PC	5697442	6119 26 8		78	RZU-A SWGR1	mustjashall	5701255	6117 36 8		68
DTS-2EP SWGR1	mustjashall/ PC	5697480	6119 27 0		78						
DTS-2PA AL1	alumiiniumvärvi/ PC	5697435	6119 26 6		79	S901F	grafitmust	5125556	6109 87 2		105
DTS-2PA RW1	polaarvalge/ PC	5697381	6119 26 2		79						
DTS-2PA SWGR1	mustjashall/ PC	5697428	6119 26 4		79						
FKH GES10	/ St / FS	5437161	7407 86 2		94	SE-B AL1	alumiiniumvärvi	5405894	6117 61 6		66
FKH GES5	/ St / FS	5437154	7407 86 0		94	SE-B RW1	polaarvalge	5405887	6117 61 5		66
FKH GESRM	/ St / FS	5437192	7407 86 4		94	SE-B SWGR1	mustjashall	5700999	6117 61 4		66
FLK-2K BL	1000 ultramariinsinine/ PVC	6277759	6154 92 4	€/m	92	SKS-CH0 RW1	polaarvalge/ PC	5008866	6117 20 0		55
FLK-2K CRW1000	kreemvalge, RAL 9001/ PVC	6277339	6154 92 0		92	SKS-CH0 RW1	polaarvalge/ PC	5008866	6117 20 0		101
FLK-2K LGR	1000 helehall/ PVC	6277575	6154 92 2		92	SKS-D0 AL1	alumiiniumvärvi/ PC	6212774	6117 00 9		52
FLK-2K SWGR	1000 mustjashall/ PVC	6277995	6154 93 0		92	SKS-D0 AL2	alumiiniumvärvi/ PC	6212835	6117 02 0		52
FLK-2K SWGR	1000 mustjashall/ PVC	6277995	6154 93 0		92	SKS-D0 AL3	alumiiniumvärvi/ PC	6213078	6117 03 1		52
FLK-BEF	/ Alu	6278473	6154 96 8	€/tk	92	SKS-D0 MZGN1	piparmündiroheline/ PC	6458530	6117 00 5		52
FLK-BS1	1000 antratsiithall/ PVC	6278657	6154 98 0		92	SKS-D0 MZGN2	piparmündiroheline/ PC	6458837	6117 01 6		52
FLK-BS2	2000 antratsiithall/ PVC	6278718	6154 98 3		92	SKS-D0 MZGN3	piparmündiroheline/ PC	6458950	6117 02 7		52
FLK-HL ZL	antratsiithall/ PVC	6278350	6154 96 1		93	SKS-D0 ROR1	oranž/ PC	6458356	6117 00 3		52
FLK-KL	50	6278534	6154 97 1		93	SKS-D0 ROR2	oranž/ PC	6458653	6117 01 4		52
FLK-TAZ	antratsiithall/ PVC	6278411	6154 96 5		93	SKS-D0 ROR3	oranž/ PC	6645077	6117 02 5		52
HG 60	oranž68/ PP	5032779	2003 41 4	€/100 tk	82	SKS-D0 RW1	polaarvalge/ PC	6458295	6117 00 1		52
HG 60 2	õnessein oranž/ PP	5032830	2003 42 2		82	SKS-D0 RW2	polaarvalge/ PC	6458295	6117 00 1		101
HG-UPM1	sinine	5406310	6119 95 0	€/tk	84	SKS-D0 RW3	polaarvalge/ PC	6518531	6117 01 2		52
HG-UPM2	sinine	5406327	6119 95 1		85	SKS-D0 SRO1	signaalpunane/ PC	6458899	6117 02 3		52
HG-UPM3	sinine	5406334	6119 95 2		86	SKS-D0 SRO2	signaalpunane/ PC	6458592	6117 00 7		52
HV 60	oranž68/ PP	5032953	2003 44 2	€/100 tk	82	SKS-D0 SRO3	signaalpunane/ PC	6471072	6117 01 8		52
KA-ZKB AL1	alumiiniumvärvi	5677888	6117 98 7	€/tk	70	SKS-D0 SWGR1	mustjashall/ PC	6597376	6117 02 9		52
KA-ZKB RW1	polaarvalge	5677864	6117 98 5		70	SKS-D0 SWGR2	mustjashall/ PC	5700883	6117 00 8		52
KA-ZKB SWGR1	mustjashall	5677871	6117 98 6		70	SKS-D0 SWGR3	mustjashall/ PC	5648956	6117 01 9		52
KS-B AL1	alumiiniumvärvi	5405931	6117 63 8	€/tk	66	SKS-D0 SWGR3	mustjashall/ PC	5700890	6117 03 0		52
KS-B RW1	polaarvalge	5405924	6117 63 7		66	SKS-D3 AL1	alumiiniumvärvi/ PC	6213139	6117 04 9		52
KS-B SWGR1	mustjashall	5701064	6117 63 9		66	SKS-D3 AL2	alumiiniumvärvi/ PC	6213191	6117 06 0		52
PAD-LQ6 AL1	alumiiniumvärvi	5406549	6119 99 9	€/100 tk	70	SKS-D3 AL3	alumiiniumvärvi/ PC	6213436	6117 07 1		52
PAD-LQ6 RW1	polaarvalge	5406532	6119 99 8		70	SKS-D3 MZGN1	piparmündiroheline/ PC	6459131	6117 04 5		52
PAD-LQ6 SWGR1	mustjashall	5701507	6119 99 7	€/tk	70	SKS-D3 MZGN2	piparmündiroheline/ PC	6459674	6117 05 6		52
					70	SKS-D3 MZGN3	piparmündiroheline/ PC	6459971	6117 06 7		52
					82	SKS-D3 ROR1	oranž/ PC	6459070	6117 04 3		52
						SKS-D3 ROR2	oranž/ PC	6459612	6117 05 4		52
						SKS-D3 ROR3	oranž/ PC	6459858	6117 06 5		52
						SKS-D3 RW1	polaarvalge/ PC	6459018	6117 04 1		52
						SKS-D3 RW2	polaarvalge/ PC	6459551	6117 05 2		52
						SKS-D3 RW3	polaarvalge/ PC	6459551	6117 05 2		101
						SKS-D3 SRO1	signaalpunane/ PC	6459797	6117 06 3		52
						SKS-D3 SRO2	signaalpunane/ PC	6459377	6117 04 7		52
						SKS-D3 SRO3	signaalpunane/ PC	6459735	6117 05 8		52
						SKS-D3 SWGR1	mustjashall/ PC	6460038	6117 06 9		52
						SKS-D3 SWGR2	mustjashall/ PC	5700906	6117 04 8		52
						SKS-D3 SWGR3	mustjashall/ PC	5700913	6117 05 9		52
						SKS-D3 SWGR3	mustjashall/ PC	5700920	6117 07 0		52
						SKS-DK0 RW1	polaarvalge/ PC	5462231	6117 20 2		55
						SKS-DK0 RW1	polaarvalge/ PC	5462231	6117 20 2		102
						SKS-DKE0 RW1	polaarvalge/ PC	5616016	6117 20 3		55

07 EGS_Katalog_2010_Neuer_Stand / et / 16/08/2010 (LLEExport_01109)

tüübiloend

EAN-koodi struktuur: riigi tähis 40 tootja tähis 1219 (artiklinumbrid, kui alguses on 0: 1010) Individuaalne EAN-C 5647589

Tüüp	Mõõtmed/värv/er.	EAN-C.	Art-nr.	hind	lehekül	Tüüp	Mõõtmed/värv/er.	EAN-C.	Art-nr.	hind	lehekül
				€/tk						€/tk	
SKS-DS3 AL2	alumiiniumvärvi/ PC	5437987	6117 08 2		60	SKS-FS3 RW2	polaarvalge/ PC	5670926	6119 86 8		60
SKS-DS3 AL3	alumiiniumvärvi/ PC	5670919	6119 86 0		60	SKS-FS3 RW3	polaarvalge/ PC	5671008	6119 88 0		60
SKS-DS3 MZGN2	piparmündiroheline/ PC	5437949	6117 07 8		60	SKS-FS3 SRO2	signaalpunane/ PC	5670971	6119 87 4		60
SKS-DS3 MZGN3	piparmündiroheline/ PC	5670889	6119 85 4		60	SKS-FS3 SRO3	signaalpunane/ PC	5671039	6119 88 6		60
SKS-DS3 ROR2	oranž/ PC	5437932	6117 07 6		60	SKS-FS3 SWGR2	mustjashall/ PC	5670988	6119 87 6		60
SKS-DS3 ROR3	oranž/ PC	5670872	6119 85 2		60	SKS-FS3 SWGR3	mustjashall/ PC	5671046	6119 88 8		60
SKS-DS3 RW2	polaarvalge/ PC	5437925	6117 07 4		60						
SKS-DS3 RW3	polaarvalge/ PC	5670865	6119 85 0		60	STA-SKS S1 SW	must	5438090	6117 19 2		60
SKS-DS3 SRO2	signaalpunane/ PC	5437970	6117 08 0		60	STA-SKS S1 W	valge	5483571	6117 19 3		60
SKS-DS3 SRO3	signaalpunane/ PC	5670896	6119 85 6		60	STA-SKS SU1 SW	must	5670933	6117 19 6		61
SKS-DS3 SWGR2	mustjashall/ PC	5700937	6117 08 1		60	STA-SKS SU1 W	valge	5670940	6117 19 7		61
SKS-DS3 SWGR3	mustjashall/ PC	5670902	6119 85 8		60						
SKS-F0 AL1	alumiiniumvärvi/ PC	6213498	6117 11 0		53						
SKS-F0 AL2	alumiiniumvärvi/ PC	6213559	6117 11 9		53	ST-F GST18i3p SW	must	5273530	6108 05 0		110
SKS-F0 AL3	alumiiniumvärvi/ PC	6213795	6117 13 1		53	ST-F GST18i3p W	valge	5273547	6108 05 1		110
SKS-F0 MZGN1	piparmündiroheline/ PC	6460212	6117 10 6		53						
SKS-F0 MZGN2	piparmündiroheline/ PC	6188956	6117 11 5		53	ST-S GST18i3p SW	must	5273608	6108 05 4		110
SKS-F0 MZGN3	piparmündiroheline/ PC	6189373	6117 12 7		53	ST-S GST18i3p W	valge	5273646	6108 05 5		110
SKS-F0 ROR1	oranž/ PC	6460151	6117 10 4		53	ST-S GST18i5p SW	must	5273707	6108 07 0		111
SKS-F0 ROR2	oranž/ PC	6460458	6117 11 3		53						
SKS-F0 ROR3	oranž/ PC	6189311	6117 12 5		53						
SKS-F0 RW1	polaarvalge/ PC	6460090	6117 10 2		53	TA-B AL0.5	alumiiniumvärvi	5276050	6117 67 1		64
SKS-F0 RW1	polaarvalge/ PC	6460090	6117 10 2		101	TA-B AL1	alumiiniumvärvi	5623816	6117 67 4		64
SKS-F0 RW2	polaarvalge/ PC	6460335	6117 11 1		53	TA-B RW0.5	polaarvalge	5276043	6117 67 0		64
SKS-F0 RW3	polaarvalge/ PC	6189076	6117 12 3		53	TA-B RW1	polaarvalge	5623809	6117 67 3		64
SKS-F0 SRO1	signaalpunane/ PC	6460274	6117 10 8		53	TA-B SWGR0.5	mustjashall	5701156	6117 66 8		64
SKS-F0 SRO2	signaalpunane/ PC	6189014	6117 11 7		53	TA-B SWGR1	mustjashall	5701323	6117 66 9		64
SKS-F0 SRO3	signaalpunane/ PC	6189618	6117 12 9		53						
SKS-F0 SWGR1	mustjashall/ PC	5700944	6117 10 9		53	TAE-6F AL1	alumiiniumvärvi	6215959	6117 43 0		70
SKS-F0 SWGR2	mustjashall/ PC	5433552	6117 11 8		53	TAE-6F RW1	polaarvalge	6215713	6117 42 8		70
SKS-F0 SWGR3	mustjashall/ PC	5433569	6117 13 0		53						
SKS-F3 AL1	alumiiniumvärvi/ PC	6213856	6117 14 8		53	TA-K AL0.5	alumiiniumvärvi	5405993	6117 67 9		64
SKS-F3 AL2	alumiiniumvärvi/ PC	6213917	6117 15 9		53	TA-K RW0.5	polaarvalge	5405962	6117 67 8		64
SKS-F3 AL3	alumiiniumvärvi/ PC	6213979	6117 17 0		53	TA-K SWGR0.5	mustjashall	5701347	6117 67 7		64
SKS-F3 MZGN1	piparmündiroheline/ PC	6287291	6117 14 4		53						
SKS-F3 MZGN2	piparmündiroheline/ PC	6637218	6117 15 5		53	TA-NA AL0.5	alumiiniumvärvi	5276104	6117 67 6		64
SKS-F3 MZGN3	piparmündiroheline/ PC	6461356	6117 16 6		53	TA-NA RW0.5	polaarvalge	5276067	6117 67 5		64
SKS-F3 ROR1	oranž/ PC	6189854	6117 14 2		53	TA-NA SWGR0.5	mustjashall	5701330	6117 67 2		64
SKS-F3 ROR2	oranž/ PC	6538690	6117 15 3		53						
SKS-F3 ROR3	oranž/ PC	6461233	6117 16 4		53						
SKS-F3 RW1	polaarvalge/ PC	6189793	6117 14 0		53	TD-AB21 AL0.5	alumiiniumvärvi	5675341	6117 55 2		67
SKS-F3 RW2	polaarvalge/ PC	6460632	6117 15 1		53	TD-AB21 RW0.5	polaarvalge	5675297	6117 54 8		67
SKS-F3 RW2	polaarvalge/ PC	6460632	6117 15 1		101	TD-AB21 SWGR0.5	mustjashall	5675303	6117 55 0		67
SKS-F3 RW3	polaarvalge/ PC	6461110	6117 16 2		53	TD-AN21 AL0.5	alumiiniumvärvi	5675280	6117 54 4		67
SKS-F3 SRO1	signaalpunane/ PC	6287536	6117 14 6		53	TD-AN21 RW0.5	polaarvalge	5675242	6117 54 0		67
SKS-F3 SRO2	signaalpunane/ PC	6461059	6117 15 7		53	TD-AN21 SWGR0.5	mustjashall	5675273	6117 54 2		67
SKS-F3 SRO3	signaalpunane/ PC	6461530	6117 16 8		53						
SKS-F3 SWGR1	mustjashall/ PC	5700968	6117 14 7		53						
SKS-F3 SWGR2	mustjashall/ PC	5700975	6117 15 8		53	TG-UP80M1	läbipaistev	5438229	6119 93 4		83
SKS-F3 SWGR3	mustjashall/ PC	5700982	6117 16 9		53	TG-UP80M1S	läbipaistev	5523024	6119 93 6		83
SKS-FC0 AL1	alumiiniumvärvi/ PC	5364191	6106 67 9		54	TG-UPM1	läbipaistev	5406341	6119 95 5		84
SKS-FC0 AL2	alumiiniumvärvi/ PC	5364269	6106 68 9		54	TG-UPM2	läbipaistev	5406358	6119 95 6		85
SKS-FC0 AL3	alumiiniumvärvi/ PC	5364375	6106 69 9		54	TG-UPM3	läbipaistev	5406365	6119 95 7		86
SKS-FC0 MZGN1	piparmündiroheline/ PC	5364177	6106 67 5		54						
SKS-FC0 MZGN2	piparmündiroheline/ PC	5364245	6106 68 5		54						
SKS-FC0 MZGN3	piparmündiroheline/ PC	5364320	6106 69 5		54					€/100 tk	
SKS-FC0 ROR1	oranž/ PC	5364146	6106 67 3		54	UG 60 D	must40/ PS	5000204	2003 01 5		82
SKS-FC0 ROR2	oranž/ PC	5364238	6106 68 3		54	UG 60 SD	punane/ PE	5029298	2003 31 7		82
SKS-FC0 ROR3	oranž/ PC	5364313	6106 69 3		54	UG 60 VD	must60/ PS	5002314	2003 01 9		82
SKS-FC0 RW1	polaarvalge/ PC	5364139	6106 67 1		54						
SKS-FC0 RW2	polaarvalge/ PC	5364207	6106 68 1		54						
SKS-FC0 RW3	polaarvalge/ PC	5364306	6106 69 1		54						
SKS-FC0 SRO1	signaalpunane/ PC	5364184	6106 67 7		54	UG-UPM1	looduslik	5406075	6119 94 0		84
SKS-FC0 SRO2	signaalpunane/ PC	5364252	6106 68 7		54	UG-UPM2	looduslik	5406082	6119 94 1		85
SKS-FC0 SRO3	signaalpunane/ PC	5364368	6106 69 7		54	UG-UPM3	looduslik	5406112	6119 94 3		86
SKS-FC3 AL1	alumiiniumvärvi/ PC	5364443	6106 70 9		54						
SKS-FC3 AL2	alumiiniumvärvi/ PC	5364535	6106 71 9		54						
SKS-FC3 AL3	alumiiniumvärvi/ PC	5364603	6106 72 9		54						
SKS-FC3 MZGN1	piparmündiroheline/ PC	5364429	6106 70 5		55	ÜSM-A		5080886	5092 45 1		56
SKS-FC3 MZGN2	piparmündiroheline/ PC	5364498	6106 71 5		54	ÜSM-A		5080886	5092 45 1		61
SKS-FC3 MZGN3	piparmündiroheline/ PC	5364566	6106 72 5		54	ÜSM-A		5080886	5092 45 1		69
SKS-FC3 ROR1	oranž/ PC	5364412	6106 70 3		54						
SKS-FC3 ROR2	oranž/ PC	5364481	6106 71 3		54	ÜSS 45-A-ALU	alumiiniumvärvi	5006220	6117 46 7		69
SKS-FC3 ROR3	oranž/ PC	5364559	6106 72 3		55	ÜSS 45-A-RW	polaarvalge	6117611	6117 46 5		69
SKS-FC3 RW1	polaarvalge/ PC	5364382	6106 70 1		54	ÜSS 45-O-ALU	alumiiniumvärvi	5006213	6117 47 5		69
SKS-FC3 RW2	polaarvalge/ PC	5364474	6106 71 1		54	ÜSS 45-O-RW	polaarvalge	6117673	6117 47 3		69
SKS-FC3 RW3	polaarvalge/ PC	5364542	6106 72 1		55						
SKS-FC3 SRO1	signaalpunane/ PC	5364436	6106 70 7		54						
SKS-FC3 SRO2	signaalpunane/ PC	5364504	6106 71 7		54	UVS-6S2	/ St	5122265	6108 00 0		109
SKS-FC3 SRO3	signaalpunane/ PC	5364597	6106 72 7		55	UVS-6S2SA	/ St	5522997	6108 01 2		109
SKS-FS3 AL2	alumiiniumvärvi/ PC	5670995	6119 87 8		60	UVS-6S6W2	/ St	5122289	6108 01 0		109
SKS-FS3 AL3	alumiiniumvärvi/ PC	5671084	6119 89 0		60	UVS-6S6W2SA	/ St	5523017	6108 01 6		109
SKS-FS3 MZGN2	piparmündiroheline/ PC	5670964	6119 87 2		60	UVS-6W2	/ St	5122272	6108 00 5		109
SKS-FS3 MZGN3	piparmündiroheline/ PC	5671022	6119 88 4		60	UVS-6W2SA	/ St	5523000	6108 01 4		109
SKS-FS3 ROR2	oranž/ PC	5670957	6119 87 0		60						
SKS-FS3 ROR3	oranž/ PC	5671015	6119 88 2		60	VB-3 GST18i3p	must	5273721	6108 08 0		110

Tüüp	Möötm/värv/er.	EAN-C.	Art-nr.	hind	lehekül	Tüüp	Möötm/värv/er.	EAN-C.	Art-nr.	hind	lehekül
VB-5 GST18i3p	must	5273769	6108 08 2	€/tk	111	VL-3Q1.5 9 W		5122869	6108 13 3	€/tk	112
						VL-3Q2.5 1 SW		5123064	6108 15 0		112
						VL-3Q2.5 1 W		5123422	6108 17 5		113
VB-SKS S	must	5438113	6117 19 8		61	VL-3Q2.5 10 SW		5123248	6108 15 9		112
						VL-3Q2.5 10 W		5123552	6108 18 4		113
						VL-3Q2.5 11 SW		5123286	6108 16 0		112
VB-T GST18i3p	must	5273776	6108 08 4		111	VL-3Q2.5 11 W		5123569	6108 18 5		113
						VL-3Q2.5 12 SW		5123293	6108 16 1		112
						VL-3Q2.5 12 W		5123576	6108 18 6		113
VH-4 3SD1C16	grafiitmust/ PA	5125075	6109 80 4		98	VL-3Q2.5 13 SW		5123309	6108 16 2		112
VH-4 3SF1C16	grafiitmust/ PA	5125099	6109 80 8		98	VL-3Q2.5 13 W		5123590	6108 18 7		113
VH-4 4SD	grafiitmust/ PA	5125044	6109 80 2		98	VL-3Q2.5 14 SW		5123347	6108 16 3		112
VH-4 4SF	grafiitmust/ PA	5125082	6109 80 6		98	VL-3Q2.5 14 W		5123606	6108 18 8		113
VH-4 LG	grafiitmust/ PA	5125037	6109 80 0		98	VL-3Q2.5 15 SW		5123354	6108 16 4		112
VH-4 TW	grafiitmust/ PVC	5125266	6109 83 2		100	VL-3Q2.5 15 W		5123613	6108 18 9		113
VH-4L 3SD1C16	grafiitmust/ PA	5125143	6109 81 4		99	VL-3Q2.5 2 SW		5123101	6108 15 1		112
VH-4L 3SF1C16	grafiitmust/ PA	5125167	6109 81 8		99	VL-3Q2.5 2 W		5123453	6108 17 6		113
VH-4L 4SD	grafiitmust/ PA	5125136	6109 81 2		98	VL-3Q2.5 3 SW		5123118	6108 15 2		112
VH-4L 4SF	grafiitmust/ PA	5125150	6109 81 6		99	VL-3Q2.5 3 W		5123460	6108 17 7		113
VH-4L LG	grafiitmust/ PA	5125105	6109 81 0		98	VL-3Q2.5 4 SW		5123125	6108 15 3		112
						VL-3Q2.5 4 W		5123477	6108 17 8		113
VH-8 LG	grafiitmust/ PA	5287391	6109 82 1		99	VL-3Q2.5 5 SW		5123163	6108 15 4		112
VH-8 LG8P2	grafiitmust/ PA	5125198	6109 82 0		99	VL-3Q2.5 5 W		5123484	6108 17 9		113
VH-8 TW	grafiitmust/ PVC	5125440	6109 86 2		100	VL-3Q2.5 6 SW		5123170	6108 15 5		112
VH-8L LG	grafiitmust/ PA	5125211	6109 82 5		99	VL-3Q2.5 6 W		5123514	6108 18 0		113
						VL-3Q2.5 7 SW		5123187	6108 15 6		112
VHF-8 LG	grafiitmust/ PA	5125204	6109 82 2		103	VL-3Q2.5 7 W		5123521	6108 18 1		113
						VL-3Q2.5 8 SW		5123224	6108 15 7		112
VH-F80	/ St	5287407	6109 83 1		100	VL-3Q2.5 8 W		5123538	6108 18 2		113
						VL-3Q2.5 9 SW		5123231	6108 15 8		112
VHF-8L LG	grafiitmust/ PA	5125228	6109 82 7		103	VL-3Q2.5 9 W		5123545	6108 18 3		113
VHF-AE4TE		5125341	6109 85 0		104	VL-3Q2.5 H1 SW		5124368	6108 45 0		113
VHF-F100	/ St	5125259	6109 83 0		103	VL-3Q2.5 H1 W		5124733	6108 47 5		113
VHF-P1	rapsikollane/ PVC	5125532	6109 86 8		104	VL-3Q2.5 H10 SW		5124542	6108 45 9		113
VHF-P10	rapsikollane/ PVC	5125457	6109 86 3		103	VL-3Q2.5 H10 W		5124894	6108 48 4		113
VHF-P11	rapsikollane/ PVC	5125464	6109 86 4		104	VL-3Q2.5 H11 SW		5124559	6108 46 0		113
VHF-P3	rapsikollane/ PVC	5125501	6109 86 5		104	VL-3Q2.5 H11 W		5124900	6108 48 5		113
VHF-P6	rapsikollane/ PVC	5125525	6109 86 7		104	VL-3Q2.5 H12 SW		5124566	6108 46 1		113
VHF-P7	rapsikollane/ PVC	5477440	6109 87 8		104	VL-3Q2.5 H12 W		5124917	6108 48 6		113
VHF-P8	rapsikollane/ PVC	5477457	6109 87 9		104	VL-3Q2.5 H13 SW		5124603	6108 46 2		113
VHF-P9	rapsikollane/ PVC	5125518	6109 86 6		104	VL-3Q2.5 H13 W		5124924	6108 48 7		113
VHF-T1	/ St	5125372	6109 85 2		105	VL-3Q2.5 H14 SW		5124610	6108 46 3		113
VHF-T2	/ St	5125389	6109 85 4		105	VL-3Q2.5 H14 W		5124955	6108 48 8		113
VHF-TW	grafiitmust/ PVC	5125396	6109 86 0		103	VL-3Q2.5 H15 SW		5124627	6108 46 4		113
VHF-TW L	grafiitmust/ PVC	5125402	6109 86 1		103	VL-3Q2.5 H15 W		5124962	6108 48 9		113
						VL-3Q2.5 H2 SW		5124375	6108 45 1		113
				€/m	100	VL-3Q2.5 H2 W		5124740	6108 47 6		113
VH-K800	/ St	5125549	6109 87 0		100	VL-3Q2.5 H3 SW		5124382	6108 45 2		113
VH-K800	/ St	5125549	6109 87 0		103	VL-3Q2.5 H3 W		5124788	6108 47 7		113
						VL-3Q2.5 H4 SW		5124429	6108 45 3		113
				€/tk	101	VL-3Q2.5 H4 W		5124795	6108 47 8		113
VH-P1	rapsikollane/ PA	5125334	6109 84 2		100	VL-3Q2.5 H5 SW		5124436	6108 45 4		113
VH-P2	rapsikollane/ PA	5125273	6109 83 4		100	VL-3Q2.5 H5 W		5124801	6108 47 9		113
VH-P3	rapsikollane/ PA	5125310	6109 83 8		101	VL-3Q2.5 H6 SW		5124443	6108 45 5		113
VH-P4	rapsikollane/ PA	5125327	6109 84 0		100	VL-3Q2.5 H6 W		5124832	6108 48 0		113
VH-P5	rapsikollane/ PA	5125280	6109 83 6		100	VL-3Q2.5 H7 SW		5124481	6108 45 6		113
VH-P7	rapsikollane/ PA	5428459	6109 83 9		100	VL-3Q2.5 H7 W		5124849	6108 48 1		113
						VL-3Q2.5 H8 SW		5124498	6108 45 7		113
VL-3Q1.5 1 SW		5122326	6108 10 0		112	VL-3Q2.5 H8 W		5124856	6108 48 2		113
VL-3Q1.5 1 W		5122692	6108 12 5		112	VL-3Q2.5 H9 SW		5124504	6108 45 8		113
VL-3Q1.5 10 SW		5122500	6108 10 9		112	VL-3Q2.5 H9 W		5124863	6108 48 3		113
VL-3Q1.5 10 W		5122876	6108 13 4		112						
VL-3Q1.5 11 SW		5122517	6108 11 0		112						
VL-3Q1.5 11 W		5122883	6108 13 5		112	WG-AF11TW RW	polaarvalge/ PC	5670414	6109 92 7		88
VL-3Q1.5 12 SW		5122524	6108 11 1		112	WG-AF2L RW	polaarvalge/ PC	5670384	6109 92 4		88
VL-3Q1.5 12 W		5122920	6108 13 6		112	WG-AF2TE RW	polaarvalge/ PC	5125815	6109 93 2		88
VL-3Q1.5 13 SW		5122562	6108 11 2		112	WG-AK RW	polaarvalge/ PC	5125730	6109 90 0		87
VL-3Q1.5 13 W		5122937	6108 13 7		112						
VL-3Q1.5 14 SW		5122579	6108 11 3		112						
VL-3Q1.5 14 W		5122944	6108 13 8		112	WG-MK RW	polaarvalge/ PC	5125747	6109 90 5		87
VL-3Q1.5 15 SW		5122586	6108 11 4		112	WG-MKL RW	polaarvalge/ PC	5670360	6109 90 9		87
VL-3Q1.5 15 W		5122982	6108 13 9		112						
VL-3Q1.5 2 SW		5122333	6108 10 1		112	WG-UBR2 RW	polaarvalge/ PC	5125822	6109 93 4		87
VL-3Q1.5 2 W		5122708	6108 12 6		112	WG-UBR3 RW	polaarvalge/ PC	5125860	6109 93 6		87
VL-3Q1.5 3 SW		5122340	6108 10 2		112	WG-UBR4 RW	polaarvalge/ PC	5125877	6109 93 8		88
VL-3Q1.5 3 W		5122746	6108 12 7		112	WG-UBR5 RW	polaarvalge/ PC	5125884	6109 94 0		88
VL-3Q1.5 4 SW		5122388	6108 10 3		112	WG-UBR6 RW	polaarvalge/ PC	5125921	6109 94 2		88
VL-3Q1.5 4 W		5122753	6108 12 8		112	WG-UK2	/ St / FS	5125938	6109 95 0		87
VL-3Q1.5 5 SW		5122395	6108 10 4		112	WG-UK3	/ St / FS	5125945	6109 95 2		87
VL-3Q1.5 5 W		5122760	6108 12 9		112	WG-UK4	/ St / FS	5125983	6109 95 4		87
VL-3Q1.5 6 SW		5122401	6108 10 5		112	WG-UK5	/ St / FS	5125990	6109 95 6		88
VL-3Q1.5 6 W		5122807	6108 13 0		112	WG-UK6	/ St / FS	5126003	6109 95 8		88
VL-3Q1.5 7 SW		5122449	6108 10 6		112						
VL-3Q1.5 7 W		5122814	6108 13 1		112	WS-B AL0.5	alumiiniumvärvi	5275756	6117 62 8		65
VL-3Q1.5 8 SW		5122456	6108 10 7		112	WS-B AL1	alumiiniumvärvi	5275862	6117 64 1		65
VL-3Q1.5 8 W		5122821	6108 13 2		112	WS-B RW0.5	polaarvalge	5275749	6117 62 7		65
VL-3Q1.5 9 SW		5122463	6108 10 8		112	WS-B RW1	polaarvalge	5275824	6117 64 0		65

07 EGS_Katalog_2010_Neuer_Stand / et / 16/08/2010 (LLEExport_01109)

tüübiloend

EAN-koodi struktuur: riigi tähis **40** tootja tähis **1219** (artiklinumbrid, kui alguses on **0: 1010**) Individuaalne EAN-C **5647589**

Tüüp	Mõõtmed/värv/er.	EAN-C.	Art-nr.	hind	lehekül					
WS-B SWGR0.5	mustjashall	5701033	6117 62 6	€/tk	65					
WS-B SWGR1	mustjashall	5701071	6117 64 2		65					
WS-K AL0.5	alumiiniumvärvi	5275800	6117 63 1		65					
WS-K RW0.5	polaarvalge	5275763	6117 63 0		65					
WS-K SWGR0.5	mustjashall	5701040	6117 62 9		65					
WS-NA AL0.5	alumiiniumvärvi	5285953	6117 63 6		65					
WS-NA RW0.5	polaarvalge	5275817	6117 63 4		65					
WS-NA SWGR0.5	mustjashall	5701057	6117 63 3		65					
ZL-SKS	kreemvalge, RAL 9001 / PVC	6180196	6117 20 5		55					
ZL-SKS	kreemvalge, RAL 9001 / PVC	6180196	6117 20 5		61					
ZU-A AL1	alumiiniumvärvi	5443681	6117 35 4		68					
ZU-A RW1	polaarvalge	5443674	6117 35 2		68					
ZU-A SWGR1	mustjashall	5701217	6117 35 6		68					

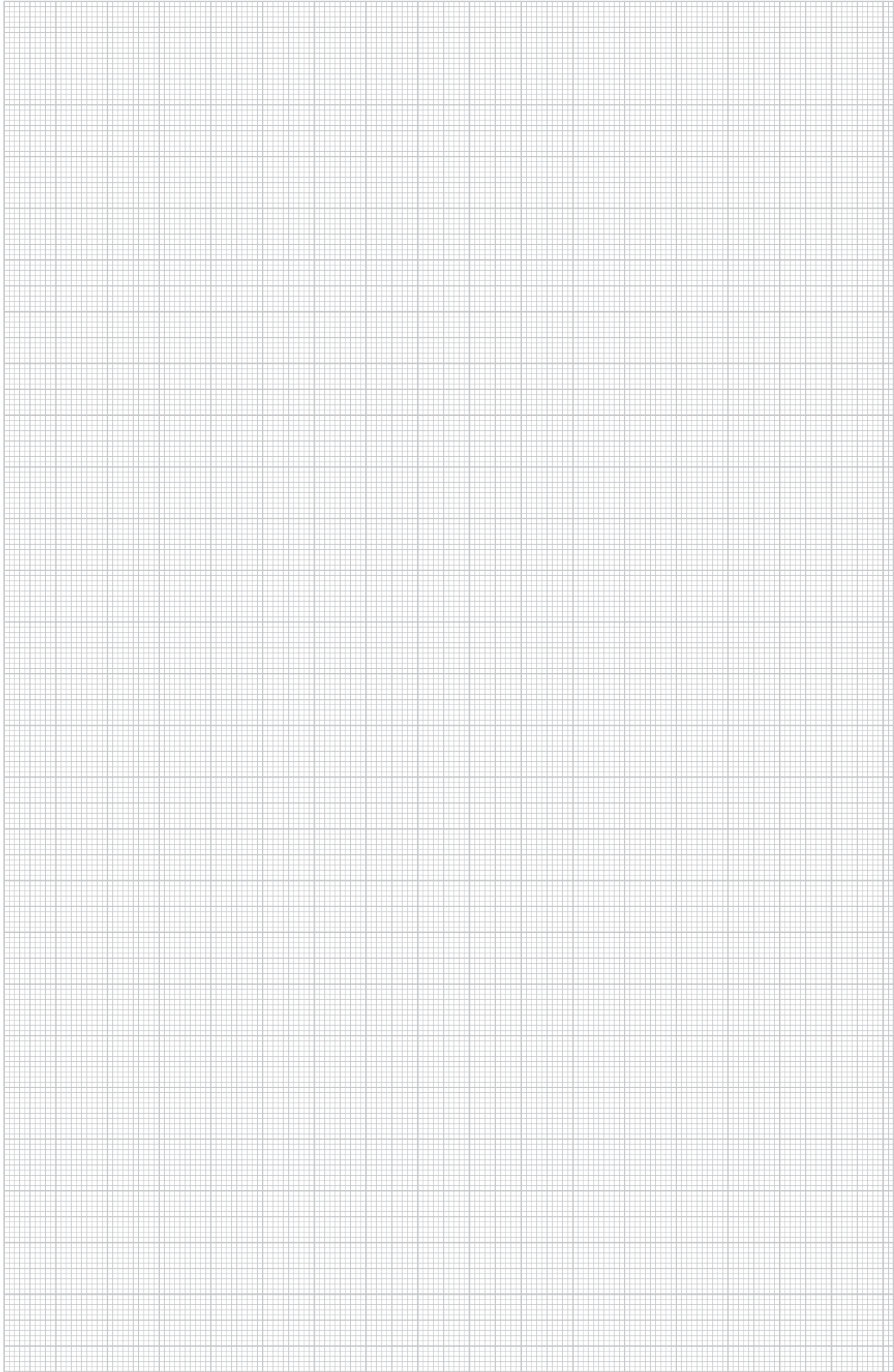



QR-Code

QR-CODE'i abil on teil alati vahetu juurdepääs meie toodetele internetis.

Lisateavet QR-Code'i kohta leiate meie veebilehelt www.obo.de.

OBO Bettermann GmbH & Co. KG

Postfach 1120
D-58694 Menden

Klienditeenindus Saksamaal

Tel. 0 23 73/89-15 00
Faks 0 23 73/89-77 77
e-post: info@obo.de

www.obo.ee