

Catalogue 2010/2011



Underfloor systems

Welcome to Customer Service

Service telephone: +49 (0)2373 89-1500

Fax for enquiries: +49 (0)2373 89-7777

Fax for orders: +49 (0)2373 89-7755

E-mail: info@obo.de

Internet: www.obo.de



Use the direct line to OBO Customer Service! On the Service Hotline +49 (0)2373 89-1500, we are available every day from 7.30 am to 5.00 p.m. for any questions about the OBO product range for electrical installations. The newly structured OBO Customer Service can offer you the full service:

- Competent contacts from your region
- All the information on the OBO product range
- Knowledgeable advice on special application topics
- Quick, direct access to all the technical data of the OBO products – we also want to provide the best in customer relations!

Contents

	Planning aid	6
	EÜK screed-covered duct system	205
	OKA open trunking system, screed-flush	225
	OKB open trunking system, screed-flush	247
	Duct systems for device installation from screed heights of 55 mm	257
	EBK flushfloor duct system, closed	269
	IBK in-concrete system	279
	AIK on-floor installation trunking system	289
	GES service outlets	299
	Frame cassettes and height-adjustable cassettes	317
	Heavy-duty cassettes	339
	Installation systems for accessories	347
	Device installation units above the floor, type Telitank	361
	Underfloor outlets and complete solutions	371
	Installation components for raised and cavity floors	385
	Device systems Modul 45	397
	UFS fire protection systems	405
	Directories	409



OBO UFS seminars: First-hand knowledge

With a comprehensive programme of training courses and seminars on the subject of underfloor systems, OBO is able to support its customers with specialist knowledge from a single source. Alongside the basic theoretical principles, the programme also deals with practical implementation in everyday applications. Special calculation and application examples round off the comprehensive programme of knowledge transfer.

Invitations to tender, product information and datasheets

We can make life easier for you. With our comprehensive selection of materials designed for practical applications, which provide you with effective support with the planning and calculation of a project. These include:

- Invitations to tender
- Product information
- Information sheets
- Datasheets

These documents are continually updated and can be downloaded at no charge at any time from the Internet download area at www.obo.de.

Invitations to tender on the Internet at

www.ausschreiben.de

More than 10,000 entries from the KTS, BSS, TBS, LFS, EGS and UFS ranges can be called up free of charge. Regular updates and expansions mean that you always have a comprehensive overview of the OBO products. All the current file formats – PDF, DOC, GAEB, HTML, TEXT, XML, ÖNORM – are available.

www.ausschreiben.de

Planning and mounting aids

	General planning aid	6
	EÜK screed-covered duct system	15
	OKA open trunking system, screed-flush	31
	OKB open trunking system, screed-flush	45
	Duct system for device installation from screed heights of 55 mm	53
	EBK flushfloor duct system, closed	61
	IBK in-concrete duct system	69
	AIK on-floor installation trunking system	75
	GES service outlets	83
	Frame cassettes and height-adjustable cassettes	99
	Heavy-duty cassettes	127
	Installation systems for accessories	145
	Device installation units above the floor, type Telitank	155
	Underfloor outlets and complete solutions	163
	Installation components for raised and cavity floors	177
	Device systems Modul 45	189
	UFS fire protection systems	195
	Additional information	199



Basic principles of planning



Installation requirements

The following belong to the installation requirements to be taken into account when planning and selecting an underfloor system:

- Number of services (power, communications, data)
- Filling factor
- Cable bend radii
- Reserve

Requirements from construction planning

Additional requirements for the underfloor system result from the architectural and interior requirements and other building design features. Amongst other things, the following play a role:

- Type of room (dry or wet)
- Type of floor covering
- Thickness of floor covering
- Thickness and type of screed
- Traffic loads
- Ambient temperature (under-floor heating)

Organisation requirements

Areas of application and use requirements with regard to electrical installations determine the organisation requirements for an underfloor system. The following criteria are of primary importance:

- Flexibility of use (e.g. simple adaptation to changing use specifications)
- Easy changing of device equipment
- Simple change from the ready to the unused state and vice-versa



Aesthetic requirements

Shape and aesthetic criteria are also of significance in the selection of an underfloor system. For example, in cases where principles of interior design are to be taken into account in the selection of shapes and materials.

Safety requirements

The topic of safety is playing an ever-more important role, in particular in the data technology sector. Therefore, when selecting and designing an underfloor installation, this point also requires particular attention. For example, if there is a need to protect data networks against unauthorised access.





Floor cleaning types



Correct selection of the device installation units

A component part of the OBO underfloor systems are different device installation units, which are designed to accept accessories (protective contact sockets, etc.). A key criterion for the selection of the correct device installation units is the type of floor covering. Here, a distinction is made between different cleaning types. This is because the device installation unit must be matched to the intended cleaning method (dry, moist or wet) should there be the chance of an ingress of moisture. The standard DIN EN 50085 regulates the division into the cleaning categories.

Dry care

The criterion for the classification "Dry care" is primarily fulfilled by textile floor coverings, which are regularly cleaned by vacuuming off the dirt ("dry"). Here, the standard speaks of "liquid-free or low-liquid

cleaning methods" and also defines, if cleaning solutions are used, the quantity used must be so small that there is no chance of "pool formation or saturation of the floor covering".

Moist care

Smooth floor coverings, such as linoleum, PVC sealed wooden floors, polished stone floors, etc. fulfil the precondition for the use of the moist cleaning method. The building cleaning trade defines this type of cleaning as a dust-collecting wipe in a single work-step using moist or prepared cleaning textiles. You can find a detailed description of the cleaning methods in the manual for building cleaning.





Wet care

"Wet care" is used particularly where very tough and adhesive soiling must be removed. This cleaning method is particularly applied to stone floors, tiles and ceramic floors as well as for linoleum and PVC covers. Wet care is divided up into two methods:

- Wet wiping, one-stage
- Wet wiping, two-stage

Single-stage wet wiping is suitable for low levels of soiling of floor coverings which are sensitive to moisture, such as raised floors or in IT rooms.

According to the specifications, in this method the floor covering is cleaned in a single work step using more or less strongly drained cleaning textiles (mop, wiping cloth, scouring or dusting cloth, fleece cloth). The remaining moisture is left to dry.

Two-stage wet wiping is suitable for heavier levels of soiling. The two-stage method corresponds to the classic wet wiping method: In the first stage, cleaning textiles (cloths, mops, wiping cloths, wide cleaning apparatus, etc.) apply as much cleaning fluid as is necessary to soften or dissolve strongly adhering soiling. In the second stage, any fluid and soiling remaining on the floor covering is wiped up using cleaning textiles.

Sufficient protection of the electrical installation

The right selection of the device installation units, matched to the appropriate floor type, ensure that the electrical installation is protected against the ingress of moisture and dirt. For this, the device installation units are tested according to EN 50085 and labelled appropriately. All the UFS products released by OBO BETTERMANN for use in wet-care floors fulfil the standard without any restrictions of requirements.



Protection aims, standardisation and testing

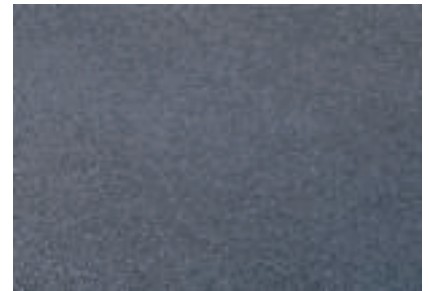

Responsibilities in standardisation

Standards can be divided up into two categories: erection specifications and device testing specifications. The installation engineer is primarily responsible for compliance with the erection specifications. The standards of the DIN VDE 0100 series define the most important requirements for electrical installations. Device testing specifications are product standards, which specify the testing criteria for specific products. The manufacturer is responsible for compliance with these regulations. Conformity with a specific testing specification is often documented by a symbol approval certificate. This confirms that an independent testing and certification institute has carried out the appropriate tests and documented the results.

European standardisation

One of the declared aims of the European Union is to replace national standards with a single European standard. This simplifies product sales and makes the internal market transparent. National deviations are only permitted when national laws make it essential. The series of standards DIN EN 50085 specifies the requirements for electrical installation duct systems. Part 2-2 deals with underfloor and on-floor systems and was

published in July 2009. For a transitional period of 2 years, either the requirements of the standard DIN VDE 0634 Part 1 and Part 2 or the requirements according to DIN EN 500845 shall apply. OBO underfloor installation systems correspond to one of these standards and have appropriate VDE symbol approval certificates.

Device testing specifications are particularly important for

- Safety (protection against electric shocks)
- The definition of the areas of application
- The function definition
- The evaluation of load capacities

Classification for underfloor systems

The DIN EN 50085-1, as a general part for electrical installation duct systems, and DIN EN 50085-2-2, as a system-specific part for underfloor system, both require classification of the products. This means there is a standard European-wide specification of product properties. For the first time, a standard for installation systems also contains load tests for vertical loads, which affect a large area (heavy load). However, this testing specification is not very practical, - meaning that OBO BETTERMANN

still tests its heavy-duty systems according to its own specification and has assigned two load classes to its heavy-duty systems: SL1 for loads of up to 10 kN and SL2 for loads up to 20 kN.



Erection specifications

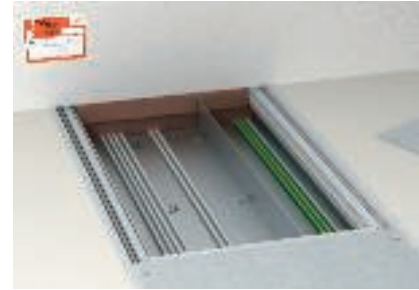

Erection regulations are used particularly for

- Safety (protection against electric shocks)
- Function maintenance
- Electromagnetic compatibility
- Fire prevention

Some important areas of the erection specifications

The erection specifications according to DIN VDE describe numerous points, which the electrical installation engineer must take into account when setting up and mounting an underfloor system. Here are some of the most important points:

Mechanical loads of cables

According to DIN VDE 0298, with both heavy current and data cables it must be ensured that specific values for strain loads and bend radii are not exceeded. The standard also described the approved types of cable fastening using clips and strain relief devices.

Separation of different services

According to DIN VDE 0100-520, cables of different current types may be installed together in a routing system if it can be guaranteed that all the cables are insulated against the next highest occurring voltage.

Protective measures and equipotential bonding

Metallic duct and trunking systems must be included in the protective measure and the equipotential bonding. This should thus ensure the protection against electric shocks (DIN VDE 0100-410) and the electromagnetic compatibility (EMC) (EN 50310, EN 50173, EN 50174-2).

Fire protection

The main causes of fire with power cables are incomplete earthing connections (e.g. on mechanically or thermally damaged cables), faulty electrical connections (loose contacts) and heat build-up.

Protection aims of fire protection

The spreading of fire and smoke into other fire sections must always be prevented over a sufficiently long period of time. This supports both attempts to escape and also effective extinguishing measures. This also applies to underfloor systems, which run under fire section and emergency and escape routes. The cable system directives (M)LAR and the system floors directive (M)SysBöR regulate this in greater detail.



Determining the cable volume

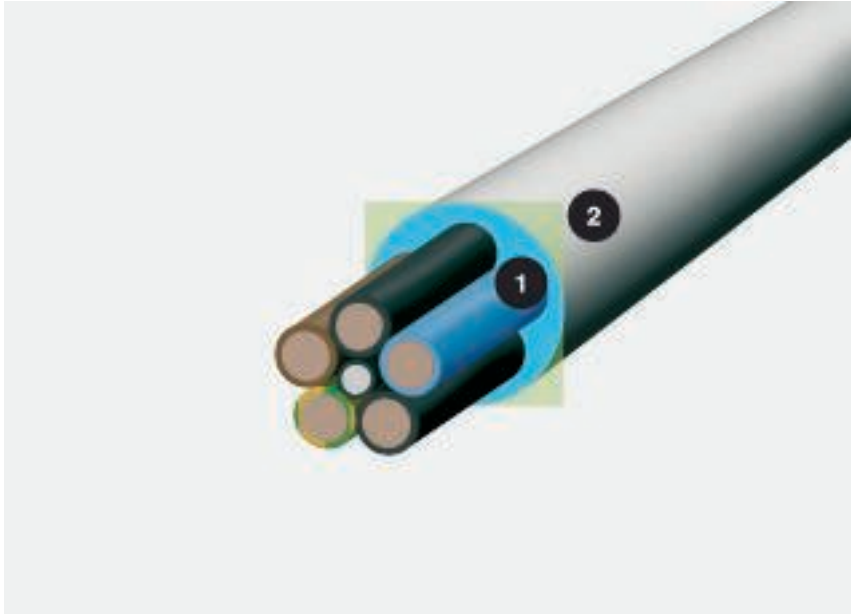

Cable diameter and space required: 1 = diameter in mm, 2 = space required in cm²



The space requirements of the cables in the UFS ducts and trunking with empty spaces

The cable volume is an important criterion for the selection of the required duct or trunking size of the underfloor system. As the cables are never packed tightly together or are absolutely parallel, it is not enough to base the volume calculation solely on the cable diameter.

A realistic calculation is provided by the formula $(2r)^2$. To simplify your work, we have listed the diameter and space requirements of the most important cable types on this double page. Important: These values are average values, which may vary from manufacturer to manufacturer. Please refer to the manufacturer's specifications for the exact values.

Calculation using the formula $(2r)^2$

The diameter says little about the actual space required by a cable. Calculate: $(2r)^2$. This value reflects the realistic space requirements, including the compartments.



Cable volume, table



Type	Diameter mm	Usable cross-section cm ²
1 x 4	6.5	0.42
1 x 6	7	0.49
1 x 10	8	0.64
1 x 16	9.5	0.9
1 x 25	12.5	1.56
3 x 1.5	8.5	0.72
3 x 2.5	9.5	0.9
3 x 4	11	1.21
4 x 1.5	9	0.81
4 x 2.5	10.5	1.1
4 x 4	12.5	1.56
4 x 6	13.5	1.82
4 x 10	16.5	2.72
4 x 16	19	3.61
4 x 25	23.5	5.52
4 x 35	26	6.76
5 x 1.5	9.5	0.9
5 x 2.5	11	1.21
5 x 4	13.5	1.82
5 x 6	14.5	2.1
5 x 10	18	3.24
5 x 16	21.5	4.62
5 x 25	26	6.76
7 x 1.5	10.5	1.1
7 x 2.5	13	1.69



Type	Diameter mm	Usable cross-section cm ²
1 x 10	10.5	1.1
1 x 16	11.5	1.32
1 x 25	12.5	1.56
1 x 35	13.5	1.82
1 x 50	15.5	2.4
1 x 70	16.5	2.72
1 x 95	18.5	3.42
1 x 120	20.5	4.2
1 x 150	22.5	5.06
1 x 185	25	6.25
1 x 240	28	7.84
1 x 300	30	9
3 x 1.5	11.5	1.32
3 x 2.5	12.5	1.56
3 x 10	17.5	3.06
3 x 16	19.5	3.8
3 x 50	26	6.76
3 x 70	30	9
3 x 120	36	12.96
4 x 1.5	12.5	1.56
4 x 2.5	13.5	1.82
4 x 6	16.5	2.72
4 x 10	18.5	3.42
4 x 16	21.5	4.62
4 x 25	25.5	6.5
4 x 35	28	7.84
4 x 50	30	9
4 x 70	34	11.56
4 x 95	39	15.21
4 x 120	42	17.64
4 x 150	47	22
4 x 185	52	27
4 x 240	58	33.6
5 x 1.5	13.5	1.82
5 x 2.5	14.5	2.1
5 x 6	18.5	3.42
5 x 10	20.5	4.2
5 x 16	22.5	5.06
5 x 25	27.5	7.56
5 x 35	34	11.56
5 x 50	40	16



Type	Diameter mm	Usable cross-section cm ²
2 x 2 x 0.6	5	0.25
4 x 2 x 0.6	5.5	0.3
6 x 2 x 0.6	6.5	0.42
10 x 2 x 0.6	7.5	0.56
20 x 2 x 0.6	9	0.81
40 x 2 x 0.6	11	1.12
60 x 2 x 0.6	13	1.69
100 x 2 x 0.6	17	2.89
200 x 2 x 0.6	23	5.29
2 x 2 x 0.8	6	0.36
4 x 2 x 0.8	7	0.49
6 x 2 x 0.8	8.5	0.72
10 x 2 x 0.8	9.5	0.9
20 x 2 x 0.8	13	1.69
40 x 2 x 0.8	16.5	2.72
60 x 2 x 0.8	20	4
100 x 2 x 0.8	25.5	6.5
200 x 2 x 0.8	32	10.24



Type	Diameter mm	Usable cross-section cm ²
Cat. 5	8	0.64
Cat. 6	8	0.64



Type	Diameter mm	Usable cross-section cm ²
SAT/BK cable	6.8	0.48



Each building requires an individual solution for electrical installations. The Modul 45 series from OBO means that it is always possible to find a functional and aesthetically pleasing solution. Modul 45 can be used universally.

Devices



System description	
Universal data technology support	190
Mounting aid	
Socket	191
Connection module with support plate	192



Universal data technology support for Modul 45

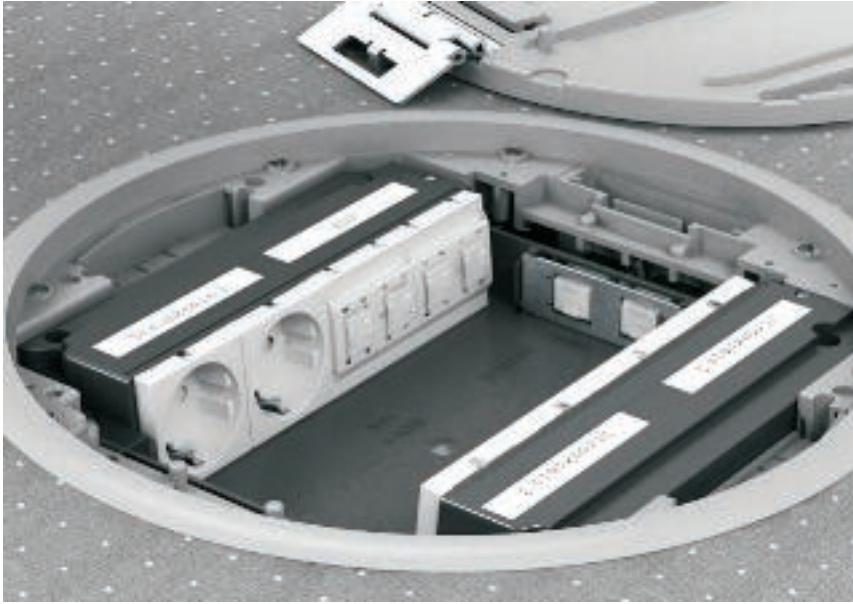

OBO can offer a universally applicable data technology support with straight connection direction for device installations with data modules. Connection cables can be attached simply and safely and do not impede each other. Integrated dust protection flaps cover the modules when unused and protect them against dust and other outside influences. When in use, the flaps are pushed up, and they close again automatically when the connection cable is removed. The scope of delivery contains an inscription label with a transparent cover. The inscription label is designed for strip labels of up to 12 mm width. The data technology support consists of two components which are combined under a single order number. The base support assumes the function of installation in the system environment whilst the system-specific module support accepts the data modules. Each data technology support can accept up to two data modules.



Mounting aid, socket



Device mounting in GB mounting boxes

The device is mounted without screws in cover plates and GB mounting boxes.

Note:

Lock Modul 45 devices into the cover plate for connecting the cable.



Socket mounting in MT module support

Safety

When mounting sockets in module supports, always use a protective housing.

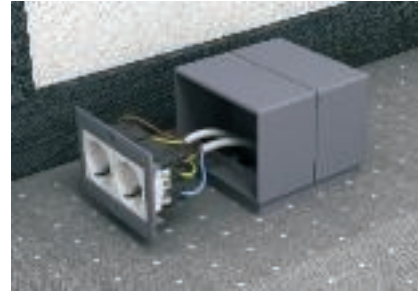

Socket mounting in Telitank

Before connecting cables, lock the Modul 45 device in the cover plate.



Socket mounting in complete unit GE2V

Before connecting the cable, lock the Modul 45 device in the metal support.



Mounting aid, connection module with support plate



Device connection – cable preparation

Remove the outer jacket of the data technology cable and, if necessary, the insulation to a length of 50 mm.



Device connection – strain relief

Attach the cable to the cable seat and relieve the strain using the enclosed cable ties. With shielded cables, ensure that the contacting strap is connected to the shield.



Device connection – cable sorting

Attach the individual wires according to the connection table and fix them using the contacting terminal.



Device connection – shorted cable excess

Cut off the excess cable length with cutters.



Device connection – cable attachment

Place the contacting bracket on the connection module and lock it in place. In the shielded version, the shield housing must also be attached.



Device connection as RJ11 telephone socket

When used as a telephone connection box, wire only the inner connection points. The reducing frame (type DMZ-RR/RJ11) prevents unintentional insertion of RJ45 connectors into the telephone socket.



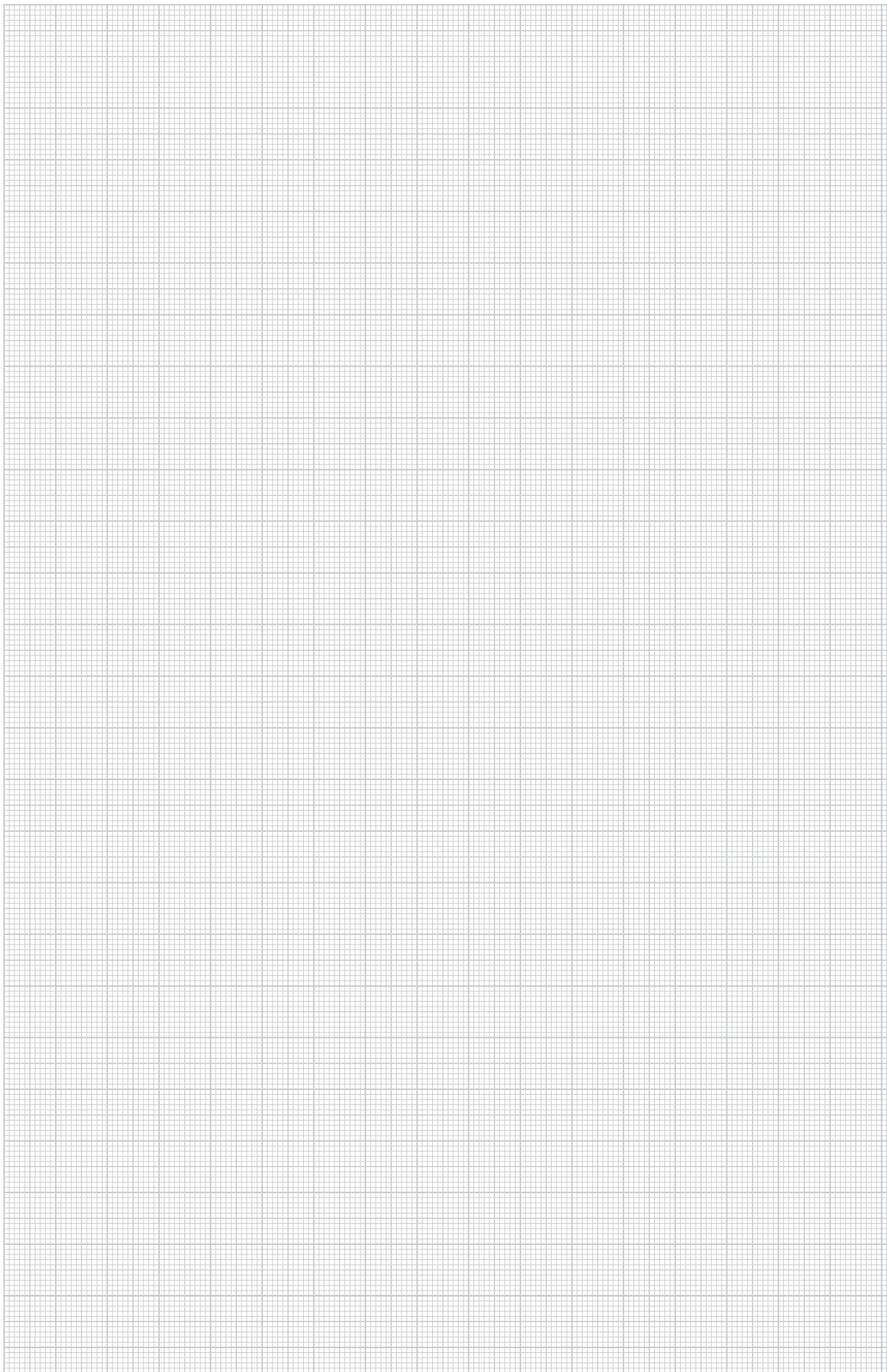

Metal materials

Alu — Aluminium

AlG — Cast aluminium

VA (1.4301) — Stainless steel, 1.4301

CuZn — Brass

St — Steel



Plastic materials

GUM — Rubber

HP — Hard cardboard

PA — Polyamide

Temperature resistance:

permanently up to approx. 90 °C, briefly up to about 130 °C and to about minus 40 °C*.

Chem. resistance generally as for polyethylene.

Resistant to

Petrol, benzene, diesel oil, acetone, solvents for paints and lacquers, oils and greases.

Unstable with

Bleach, most acids, chlorine.

Risk of tension cracking

Low in air-humid conditions; only with some aqueous salt solutions.

Highly desiccated parts (high temperature and extremely low air humidity) are highly sensitive to fuels and various solvents.

PA/GF — Polyamide, fibreglass reinforced

Temperature resistance:

permanently up to 100–110 °C, briefly up to 160 °C and to about minus 40 °C*.

Resistant to

Petrol, benzene, diesel oil, acetone, solvents for paints and lacquers, oils and greases.

Slightly susceptible to stress-cracking.

Unstable with

Bleach, most acids, chlorine.

Risk of tension cracking

Low in air-humid conditions; only with some aqueous salt solutions.

Highly desiccated parts (high temperature and extremely low air humidity) are highly sensitive to fuels and various solvents.

PE — Polyethylene

Temperature resistance:

hard types permanently up to about 90 °C, briefly up to about 105 °C, soft types permanently up to about 80 °C, briefly up to about 100 °C and to about minus 40 °C*.

Resistant to

Alkalis and inorganic acids.

Conditionally resistant to

Acetone, organic acids, petrol, benzene, diesel oil, most oils.

Unstable with

Chlorine, hydrocarbons, oxidising acids.

Risk of tension cracking

Relatively high.

Stress cracks can be caused by, among others, acetone, various alcohols, formic acid, ethanol, petrol, benzene, butyric acid, acetic acid, formaldehyde, various oils, petroleum, propanol, nitric acid, hydrochloric acid, sulphuric acid, soap solutions, turpentine, trichloroethylene, citric acid.

PP — Polypropylene

Temperature resistance:

permanently up to approx. 90 °C, briefly up to about 110 °C and to about minus 30 °C*.

Chem. resistance generally as for polyethylene.

Resistant to

Alkalis and inorganic acids.

Conditionally resistant to

Acetone, organic acids, petrol, benzene, diesel oil, most oils

Unstable with

Chlorine, hydrocarbons, oxidising acids.

Risk of tension cracking

Low, only with some acids such as chromic acid, hydrofluoric acid and hydrochloric acid, as well as nitrogen oxide.

PVC — Polyvinylchloride

Temperature resistance:

permanently up to 65 °C, briefly up to 75 °C and to about minus 30 °C.

Resistant to

Weak acids, alkalis, oils and greases, petrol.

Unstable with

Strong acids, benzene, acetone, iodine, toluene, trichloroethylene.

Risk of tension cracking

Low, only with some solvents such as benzene and acetone.

MGUM — Foam rubber

*The minus values apply only for parts in the quiescent condition with no severe impact stress.

There is no plastic that is resistant to every chemical. The agents listed are only a small selection. Plastic parts are especially at risk in the presence of chemicals and high temperatures. Stress cracks may occur. If in doubt, please consult us and/or ask for a detailed chemical resistance table.

Stress crack formation: stress cracks may occur if plastic parts under tension are exposed to chemicals at the same time. Parts made of polystyrene and polyethylene are particularly susceptible. Stress cracks may even be caused by agents to which the plastic in question is resistant in the absence of stress. Typical examples of parts under constant stress when used as intended: grip clips, intermediate supports of cable glands, ribbon clips.



Classification to EN 50085-1

		Screed-covered: EÜK ducts	Screed-flush: EÜK sockets, DUG, etc.	Screed-flush systems, OKA	Screed-flush systems, EBK	On-floor systems	GES service outlets	Height-adjustable cassettes	Frame cassettes	Heavy-duty support (UZD + cassettes)
		EÜK	UZD	OKA	EBK	AIK	GES	RK.N	RK	.SL
6.1	According to material									
	Under consultation									
6.2	According to impact resistance for installation and application									
6.2.1	Electrical installation duct systems for impact energy 0.5 J.									
6.2.2	Electrical installation duct systems for impact energy 1 J.									
6.2.3	Electrical installation duct systems for impact energy 2 J.									
6.2.4	Electrical installation duct systems for impact energy 5 J.						x	x	x	x
6.2.5	Electrical installation duct systems for impact energy 20 J.	x	x	x	x	x				
6.3	According to temperature, as specified in the Tables 1, 2 and 3									
Table 1	Minimum storage and transport temperatures $\pm 2 \text{ }^\circ\text{C}$									
	-45									
	-25	x	x	x	x	x				
	-15						x	x	x	x
	-5									
Table 2	Minimum installation and application temperatures $\pm 2 \text{ }^\circ\text{C}$									
	-25									
	-15									
	-5									
	+5	x	x	x	x	x	x	x	x	x
	+15									
Table 3	Maximum application temperatures $\pm 2 \text{ }^\circ\text{C}$									
	+60	x	x	x	x	x	x	x	x	x
	+90									
	+105									
	+120									

Classification to EN 50085-1

		Screed-covered: EÜK ducts	Screed-flush: EÜK sockets, DUG, etc.	Screed-flush systems, OKA	Screed-flush systems, EBK	On-floor systems	GES service outlets	Height-adjustable cassettes	Frame cassettes	Heavy-duty support (UZD + cassettes)
		EÜK	UZD	OKA	EBK	AIK	GES	RK.N	RK	.SL
6.4	According to the resistance against fire spread									
6.4.1	Electrical installation duct systems which allow the spread of fire						x	(x)	(x)	
6.4.2	Electrical installation duct systems which do not permit the spread of fire	x	x	x	x	x				x
6.5	According to the electrical conductivity									
6.5.1	Electrical installation duct system with electrical conductivity	x	x	x	x	x	x	x	x	x
6.5.2	Electrical installation duct system without electrical conductivity									
6.6	According to the electrical insulation property									
6.6.1	Electrical installation duct system without electrical insulation property	x	x	x	x	x				x
6.6.2	Electrical installation duct system with electrical insulation property						x	x	x	
6.7	According to the protection ratings offered by the housing or casing to EN 60529:1991									
6.7.1	According to protection against ingress of solid foreign bodies	x	x	x	x	x	x	x	x	x
6.7.2	According to protection against ingress of water		x	x				x	x	x
6.7.3	According to protection against contact with dangerous parts						x	x	x	x



Classification to EN 50085-2-2

		Screed-covered: EÜK ducts	Screed-flush: EÜK sockets, DUG, etc.	Screed-flush systems, OKA	Screed-flush systems, EBK	On-floor systems	GES service outlets	Height-adjustable cassettes	Frame cassettes	Heavy-duty support (UZD + cassettes)
		EÜK	UZD	OKA	EBK	AIK	GES	RK.N	RK	.SL
6.101	Depending on the type of floor cleaning									
6.101.1	Electrical installation duct system for dry floor cleaning									
6.101.2	Electrical installation duct system for wet floor cleaning when the service outlet is not in use		x					x	x	x
6.101.3	Electrical installation duct system for wet floor cleaning when the service outlet is in use		x					x	x	x
6.102	According to resistance to vertical load applied through small surface area									
6.102.1	Electrical installation duct system for 500 N									
6.102.2	Electrical installation duct system for 750 N	x								
6.102.3	Electrical installation duct system for 1000 N									
6.102.4	Electrical installation duct system for 1500 N					x				
6.102.5	Electrical installation duct system for 2000 N						x			
6.102.6	Electrical installation duct system for 2500 N									
6.102.7	Electrical installation duct system for 3000 N		x	x	x			x	x	
6.103	According to resistance to vertical load applied through large surface area									
6.103.1	Electrical installation duct system for 2000 N									
6.103.2	Electrical installation duct system for 3000 N							x		
6.103.3	Electrical installation duct system for 5000 N						x		x	
6.103.4	Electrical installation duct system for 10000 N									
6.103.5	Electrical installation duct system for 15000 N		x		x					x



Modul 45 devices

	Protective contact socket	0° version 33° version	398 398
	Socket with earthing pin	0° version 0° version, encoded	399 399
	Socket with earthing pin	33° version 33° version, encoded	399 400
	Encoding pin	For encoded socket	400
	Swiss standard socket	Modul 45 version	400
	Danish standard socket	Modul 45 version	401
	Surge protection module	For GB2 and GB3 mounting boxes For MT3 and MT4 module support	401 401
	Antenna socket	Modul 45	401
	Telephone connection socket	TAE system	402
	Modul 45 data technology	For connection modules with support plate	402
	Data connection module	With support plate	402
	Blind cover	Modul 45 version	403





Protective contact socket, 0°

Type	Colour	Pack.	Weight	Item No.
		pcs	kg/100 pcs.	
SKS-D0 RW1	Pure white	20	3.800	6117 00 1
SKS-D0 ROR1	Orange	20	3.800	6117 00 3
SKS-D0 MZGN1	Mint green	20	3.800	6117 00 5
SKS-D0 SRO1	Signal red	20	3.800	6117 00 7

PC Polycarbonate /pc.

Power socket single 0°, with increased touch protection with screwless terminals, 2-pin, 16 A, 250 V~, with connection terminals to IEC 60884-1.

Type	Colour	Pack.	Weight	Item No.
		pcs	kg/100 pcs.	
SKS-D0 RW2	Pure white	10	7.500	6117 01 2
SKS-D0 ROR2	Orange	10	7.500	6117 01 4
SKS-D0 MZGN2	Mint green	10	7.500	6117 01 6
SKS-D0 SRO2	Signal red	10	7.500	6117 01 8

PC Polycarbonate /pc.

Power socket double 0°, with increased touch protection with screwless terminals, 2-pin, 16 A, 250 V~, with connection terminals to IEC 60884-1.

Type	Colour	Pack.	Weight	Item No.
		pcs	kg/100 pcs.	
SKS-D0 RW3	Pure white	4	10.300	6117 02 3
SKS-D0 ROR3	Orange	4	10.300	6117 02 5
SKS-D0 MZGN3	Mint green	4	10.300	6117 02 7
SKS-D0 SRO3	Signal red	4	10.300	6117 02 9

PC Polycarbonate /pc.

Power socket triple 0°, with increased touch protection with screwless terminals, 2-pin, 16 A, 250 V~, with connection terminals to IEC 60884-1.

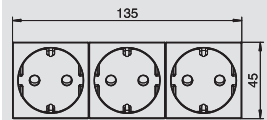
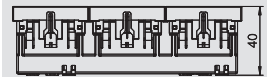
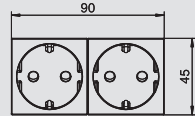
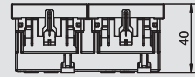
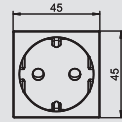
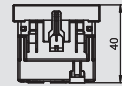

Protective contact socket, 33°

Type	Colour	Pack.	Weight	Item No.
		pcs	kg/100 pcs.	
SKS-D3 RW1	Pure white	20	3.800	6117 04 1
SKS-D3 ROR1	Orange	20	3.800	6117 04 3
SKS-D3 MZGN1	Mint green	20	3.800	6117 04 5
SKS-D3 SRO1	Signal red	20	3.800	6117 04 7
SKS-D3 AL1	Aluminium paint	20	3.800	6117 04 9

PC Polycarbonate /pc.

Power socket single 33°, with increased touch protection with screwless terminals, 2-pin, 16 A, 250 V~, with connection terminals to IEC 60884-1.

Type	Colour	Pack.	Weight	Item No.
		pcs	kg/100 pcs.	
SKS-D3 RW2	Pure white	10	7.500	6117 05 2
SKS-D3 ROR2	Orange	10	7.500	6117 05 4
SKS-D3 MZGN2	Mint green	10	7.500	6117 05 6
SKS-D3 SRO2	Signal red	10	7.500	6117 05 8
SKS-D3 AL2	Aluminium paint	10	7.500	6117 06 0

PC Polycarbonate /pc.

Power socket double 33°, with increased touch protection with screwless terminals, 2-pin, 16 A, 250 V~, with connection terminals to IEC 60884-1.

Type	Colour	Pack.	Weight	Item No.
		pcs	kg/100 pcs.	
SKS-D3 RW3	Pure white	4	10.300	6117 06 3
SKS-D3 ROR3	Orange	4	10.300	6117 06 5
SKS-D3 MZGN3	Mint green	4	10.300	6117 06 7
SKS-D3 SRO3	Signal red	4	10.300	6117 06 9
SKS-D3 AL3	Aluminium paint	4	10.300	6117 07 1

PC Polycarbonate /pc.

Power socket triple 33°, with increased touch protection with screwless terminals, 2-pin, 16 A, 250 V~, with connection terminals to IEC 60884-1.

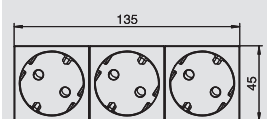
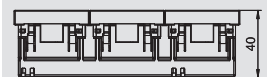
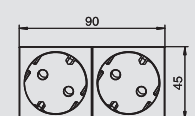
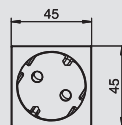
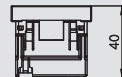

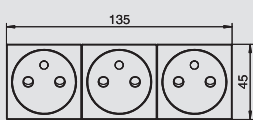
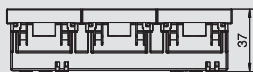
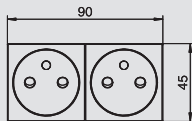
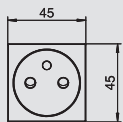
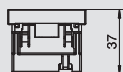

Socket with earthing pin, 0°

Type	Colour	Pack.	Weight	Item No.
		pcs	kg/100 pcs.	
SKS-F0 RW1	Pure white	20	3.800	6117 10 2
SKS-F0 ROR1	Orange	20	3.800	6117 10 4
SKS-F0 MZGN1	Mint green	20	3.800	6117 10 6
SKS-F0 SRO1	Signal red	20	3.800	6117 10 8

PC Polycarbonate /pc.

Socket with earthing pin single 0°, with increased touch protection with screwless terminals, 2-pin, 16 A, 250 V ~, with connection terminals to IEC 60884-1.

Type	Colour	Pack.	Weight	Item No.
		pcs	kg/100 pcs.	
SKS-F0 RW2	Pure white	10	7.500	6117 11 1
SKS-F0 ROR2	Orange	10	7.500	6117 11 3
SKS-F0 MZGN2	Mint green	10	7.500	6117 11 5
SKS-F0 SRO2	Signal red	10	7.500	6117 11 7

PC Polycarbonate /pc.

Socket with earthing pin double 0°, with increased touch protection with screwless terminals, 2-pin, 16 A, 250 V ~, with connection terminals to IEC 60884-1.

Type	Colour	Pack.	Weight	Item No.
		pcs	kg/100 pcs.	
SKS-F0 RW3	Pure white	4	12.000	6117 12 3
SKS-F0 ROR3	Orange	4	12.000	6117 12 5
SKS-F0 MZGN3	Mint green	4	12.000	6117 12 7
SKS-F0 SRO3	Signal red	4	12.000	6117 12 9

PC Polycarbonate /pc.

Socket with earthing pin triple 0°, with increased touch protection with screwless terminals, 2-pin, 16 A, 250 V ~, with connection terminals to IEC 60884-1.



Socket with earthing pin, 0°, encoded version

Type	Colour	Pack.	Weight	Item No.
		pcs	kg/100 pcs.	
SKS-FC0 SRO1	Signal red	20	3.800	6106 67 7

PC Polycarbonate /pc.

Socket with earthing pin single 0°, coded version with increased touch protection, with screwless terminals, 2-pin, 16 A, 250 V ~, with connection terminals to IEC 60884-1.

The socket can only be used in conjunction with an encoding pin, type CST-SKS.

Note: The encoding pin is not contained in the scope of supply.

Type	Colour	Pack.	Weight	Item No.
		pcs	kg/100 pcs.	
SKS-FC0 SRO2	Signal red	10	7.500	6106 68 7

PC Polycarbonate /pc.

Socket with earthing pin double 0°, coded version with increased touch protection, with screwless terminals, 2-pin, 16 A, 250 V ~, with connection terminals to IEC 60884-1.

The socket can only be used in conjunction with an encoding pin, type CST-SKS.

Note: The encoding pin is not contained in the scope of supply.

Type	Colour	Pack.	Weight	Item No.
		pcs	kg/100 pcs.	
SKS-FC0 SRO3	Signal red	4	10.300	6106 69 7

PC Polycarbonate /pc.

Socket with earthing pin triple 0°, coded version with increased touch protection, with screwless terminals, 2-pin, 16 A, 250 V ~, with connection terminals to IEC 60884-1.

The socket can only be used in conjunction with an encoding pin, type CST-SKS.

Note: The encoding pin is not contained in the scope of supply.



Socket with earthing pin, 33°

Type	Colour	Pack.	Weight	Item No.
		pcs	kg/100 pcs.	
SKS-F3 RW1	Pure white	20	3.800	6117 14 0
SKS-F3 ROR1	Orange	20	3.800	6117 14 2
SKS-F3 MZGN1	Mint green	20	3.800	6117 14 4
SKS-F3 SRO1	Signal red	20	3.800	6117 14 6
SKS-F3 AL1	Aluminium paint	20	3.800	6117 14 8

PC Polycarbonate /pc.

Socket with earthing pin single 33°, with increased touch protection with screwless terminals, 2-pin, 16 A, 250 V ~, with connection terminals to IEC 60884-1.



Device systems Modul 45



Socket with earthing pin, 33°

Type	Colour	Pack.	Weight		Item No.
			pcs	kg/100 pcs.	
SKS-F3 RW2	Pure white	10	7.500		6117 15 1
SKS-F3 ROR2	Orange	10	7.500		6117 15 3
SKS-F3 MZGN2	Mint green	10	7.500		6117 15 5
SKS-F3 SRO2	Signal red	10	7.500		6117 15 7
SKS-F3 AL2	Aluminium paint	10	7.500		6117 15 9

PC Polycarbonate /pc.

Socket with earthing pin double 33°, with increased touch protection with screwless terminals, 2-pin, 16 A, 250 V~, with connection terminals to IEC 60884-1.



Type	Colour	Pack.	Weight		Item No.
			pcs	kg/100 pcs.	
SKS-F3 RW3	Pure white	4	10.300		6117 16 2
SKS-F3 ROR3	Orange	4	10.300		6117 16 4
SKS-F3 MZGN3	Mint green	4	10.300		6117 16 6
SKS-F3 SRO3	Signal red	4	10.300		6117 16 8
SKS-F3 AL3	Aluminium paint	4	10.300		6117 17 0

PC Polycarbonate /pc.

Socket with earthing pin triple 33°, with increased touch protection with screwless terminals, 2-pin, 16 A, 250 V~, with connection terminals to IEC 60884-1.

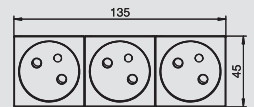
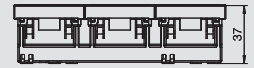
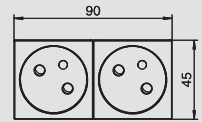

Socket with earthing pin, 33°, encoded version

Type	Colour	Pack.	Weight		Item No.
			pcs	kg/100 pcs.	
SKS-FC3 SRO1	Signal red	20	3.800		6106 70 7

PC Polycarbonate /pc.

Socket with earthing pin single 33°, coded version with increased touch protection, with screwless terminals, 2-pin, 16 A, 250 V~, with connection terminals to IEC 60884-1.

The socket can only be used in conjunction with an encoding pin, type CST-SKS.

Note: The encoding pin is not contained in the scope of supply.

Type	Colour	Pack.	Weight		Item No.
			pcs	kg/100 pcs.	
SKS-FC3 SRO2	Signal red	10	7.500		6106 71 7

PC Polycarbonate /pc.

Socket with earthing pin double 33°, coded version with increased touch protection, with screwless terminals, 2-pin, 16 A, 250 V~, with connection terminals to IEC 60884-1.

The socket can only be used in conjunction with an encoding pin, type CST-SKS.

Note: The encoding pin is not contained in the scope of supply.

Type	Colour	Pack.	Weight		Item No.
			pcs	kg/100 pcs.	
SKS-FC3 SRO3	Signal red	4	10.300		6106 72 7

PC Polycarbonate /pc.

Socket with earthing pin triple 33°, coded version with increased touch protection, with screwless terminals, 2-pin, 16 A, 250 V~, with connection terminals to IEC 60884-1.

The socket can only be used in conjunction with an encoding pin, type CST-SKS.

Note: The encoding pin is not contained in the scope of supply.

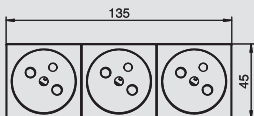
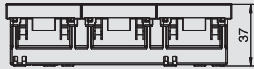
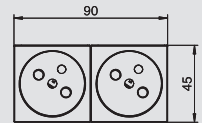
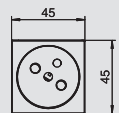
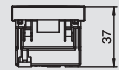

Encoding pin

Type	Colour	Pack.	Weight		Item No.
			pcs	kg/100 pcs.	
CST-SKS	Black	10	1.200		6106 73 5

PC Polycarbonate /pc.

Encoding pin for socket with earthing pin, encoded version.

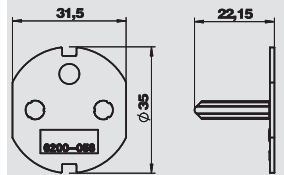

Socket, Swiss standard, Modul 45

Type	Colour	Pack.	Weight		Item No.
			pcs	kg/100 pcs.	
SKS-CH0 RW1	Pure white	1	3.400		6117 20 0

PC Polycarbonate /pc.

Socket, single 0°, to Swiss standard (SEV), with screwless terminals, 2-pin, 10 A, 250 V~, type 13, with connection terminals to IEC 60884-1.

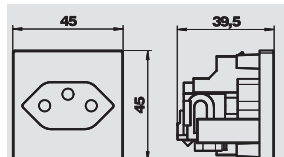

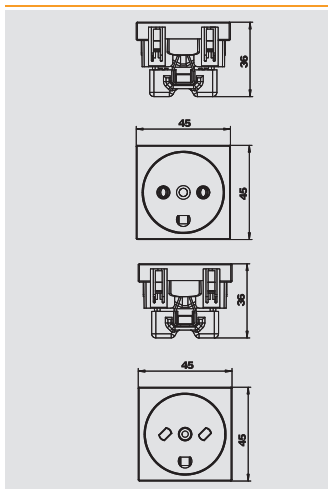

Socket, Danish standard, Modul 45, 0°

Type	Colour	Pack.	Weight	Item No.
		pcs	kg/100 pcs.	
SKS-DK0 RW1	Pure white	20	3.050	6117 20 2

PC Polycarbonate /pc.

Socket, single 0°, to Danish standard, with increased touch protection, with screw terminals, 2-pin, 16 A, 250 V~, with connection terminals to IEC 60884-1.

Type	Colour	Pack.	Weight	Item No.
		pcs	kg/100 pcs.	
SKS-DKE0 RW1	Pure white	20	3.050	6117 20 3

PC Polycarbonate /pc.

Socket, single 0°, to Danish standard, encoded for IT power circuit, with screw terminals, 2-pin, 16 A, 250 V~, with connection terminals to IEC 60884-1.

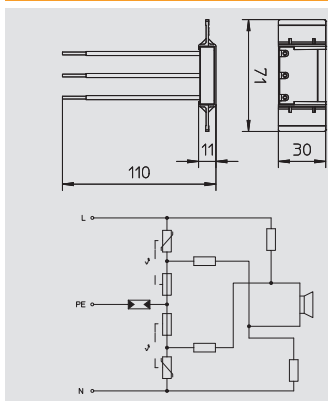

Surge protection module for mounting box GB2 and GB3

Type	Signalling on device	Pack.	Weight	Item No.
		pcs	kg/100 pcs.	
USM-A-4	Audible	1	2.000	5092 47 2

/pc.

Surge protection module with acoustic defect display, no power switch-off, for the connection of a single or multiple socket. For installation in GB2 and GB3 mounting boxes with enclosed separating retainer.

The surge protection module meets EN 61643-11, Type 3, Class III, Requirement Class D.

2-pin, 16 A/250 V~, with acoustic defect signal.

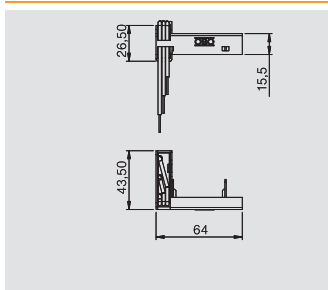

Surge protection module for module support MT3 and MT4

Type	Signalling on device	Pack.	Weight	Item No.
		pcs	kg/100 pcs.	
USM-A-4T	Audible	1	0.000	6107 80 1

/pc.

2-pole surge protection module, 16 A/250 V~, with acoustic default display, no network switch-off, for connection to a multiple socket of type Modul 45connect using the supplied support.

For installation in the module supports MT3/45 and MT4/45. The surge protection module meets EN 61643-11, Type 3, Class III, Requirements Class D.

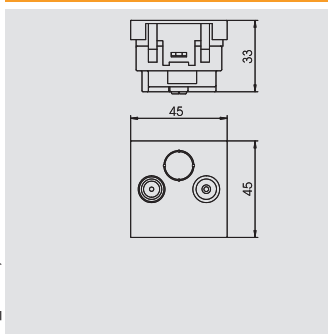

Antenna socket, terminal socket, TV and radio

Type	Colour	Pack.	Weight	Item No.
		pcs	kg/100 pcs.	
ANT-2E RW1	Pure white	10	8.100	6117 38 1

/pc.

Single socket for antenna, BK and satellite reception systems with connection for TV and radio.

Frequency: 5–862 MHz

Heat attenuation: 1 dB

Return channel attenuation: 14 dB

EMC protection class A

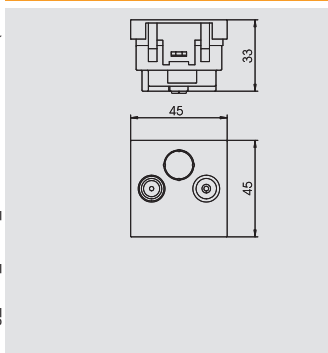

Antenna socket, pass-through socket, TV and radio

Type	Colour	Pack.	Weight	Item No.
		pcs	kg/100 pcs.	
ANT-2D RW1	Pure white	10	8.100	6117 38 7

/pc.

Through socket for antenna, BK and satellite reception systems with connection for TV and radio.

Frequency: 5–862 MHz

Through attenuation: 4 dB

Heat attenuation: 14 dB

EMC protection class A



Device systems Modul 45

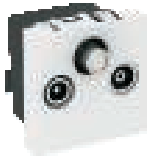

Antenna socket, terminal socket, TV, radio and SAT

Type	Colour	Pack.	Weight	Item No.
		pcs	kg/100 pcs.	
ANT-3E RW1	Pure white	10	9.400	6117 39 3

/pc.

Single socket for antenna, BK and satellite reception systems with connection for TV, radio and SAT.

Frequency: 5–2050 MHz
 Heat attenuation:
 5-862 MHz – 1 dB
 950-2050 MHz – 2 dB
 Return channel attenuation: 14 dB
 EMC protection class A

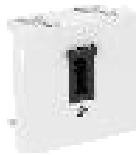
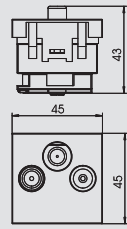

TAE telephone connection socket system

Type	Colour	Pack.	Weight	Item No.
		pcs	kg/100 pcs.	
TAE-6F RW1	Pure white	10	2.000	6117 42 8
TAE-6F AL1	Aluminium paint	10	2.000	6117 43 0

/pc.

Telephone connection box TAE 6 F.

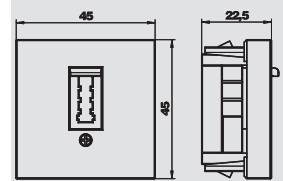

Modul 45 data technology for connection modules with support plate

Type	Colour	Pack.	Weight	Item No.
		pcs	kg/100 pcs.	
DMS-2RM RW1	Pure white	10	0.855	6117 31 5

PC Polycarbonate

/pc.

Data technology support with slanting outlet to accept two connection modules with support plate. The locking fastening is suitable for horizontal and vertical installation in the system environment.

Type	Colour	Pack.	Weight	Item No.
		pcs	kg/100 pcs.	
DMG-2RM RW1	Pure white	10	1.100	6117 31 9

/pc.

Data technology support with slanting outlet to accept two connection modules with support plate. The locking fastening is suitable for horizontal and vertical installation in the system environment.

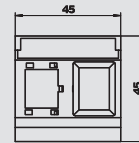
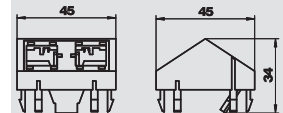

Data connection module with support plate, Cat. 5e

Type	Pack.	Weight	Item No.
	pcs	kg/100 pcs.	
ASM-C5	1	1.120	6117 33 7

/pc.

Connection module with support plate, Cat. 5e unshielded, with an RJ 45 slot. Including a dust cover, a cable tie and mounting instructions.

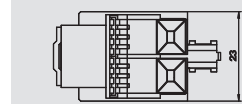
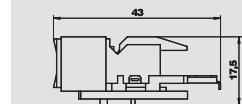

Data connection module with support plate, Cat. 5e, shielded

Type	Pack.	Weight	Item No.
	pcs	kg/100 pcs.	
ASM-C5 G	1	1.920	6117 32 5

/pc.

Connection module with support plate, Cat. 5e shielded, with an RJ 45 slot. Including an EMC screen hood, a dust cover, a cable tie and mounting instructions.

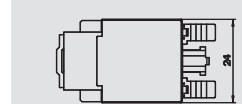
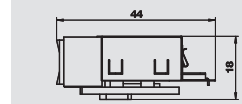

Data connection module with support plate, Cat. 6

Type	Pack.	Weight	Item No.
	pcs	kg/100 pcs.	
ASM-C6	1	1.060	6117 34 1

/pc.

Connection module with support plate, Cat. 6 unshielded, with an RJ 45 slot. Including a dust cover, a cable tie and mounting instructions.

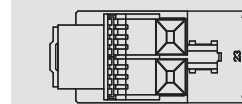
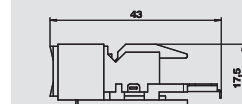

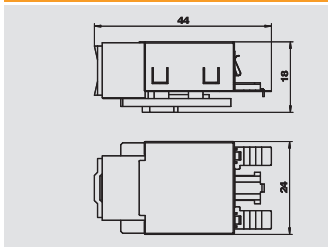

Data connection module with support plate, Cat. 6, shielded

Type	Pack.	Weight	Item No.
	pcs	kg/100 pcs.	
ASM-C6 G	1	1.850	6117 32 9



/pc.
 Connection module with support plate, Cat. 6 shielded for 10GbE, with an RJ 45 slot. Including an EMC screen hood, a dust cover, a cable tie and mounting instructions.

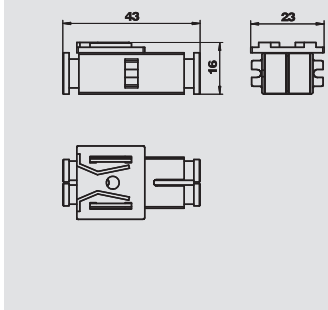

Fibre optic coupling with support plate

Type	Pack.	Weight	Item No.
	pcs	kg/100 pcs.	
ASM-LWL K	1	0.095	6117 74 0



/pc.
 Fibre optic coupling with support plate, single channel module.
 Scope of supply: coupling, support plate, two dust protection covers, one set of installation instructions, one description.
 Scope of delivery: Coupling, carrier plate, 2 dust protection covers, installation instructions, 1 description

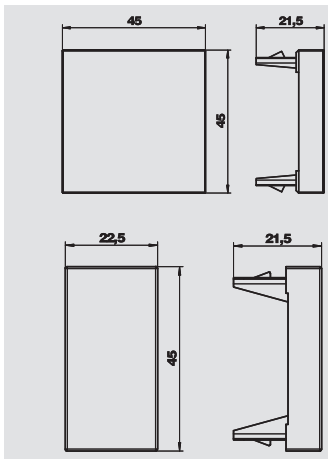

Blanking cover

Type	Colour	Pack.	Weight	Item No.
		pcs	kg/100 pcs.	
ADP-B RW1	Pure white	10	0.800	6117 40 6



Blanking cover for closing off empty spaces for a device (one module width).

Type	Colour	Pack.	Weight	Item No.
		pcs	kg/100 pcs.	
ADP-B RW0.5	Pure white	10	0.400	6117 41 4

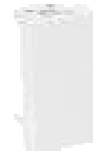





Blanking cover for closing off empty spaces for half a device (1/2 module width).





Directories

	Alphabetical table of contents	410
	Numeric directory	416
	Type listing	422
		439
	Terms and conditions of sale and delivery	



Alphabetical table of contents

3

- 3-wire connection cable, halogen-free, cross-section 2.5, 252, 391-392
- 3-wire connection cable, PVC, cross-section 1.5 mm², 251, 390
- 3-wire connection cable, PVC, cross-section 2.5 mm², 251-252, 391

A

- ACO mounting support, 357
- Antenna socket, pass-through socket, TV and radio, 401
- Antenna socket, terminal socket, TV and radio, 401
- Antenna socket, terminal socket, TV, radio and SAT, 402

B

- BAB80 mounting key, 375
- BABF80 mounting key, 375
- Basic box 250, 284-285
- Basic box 250 with screed protection cover, 284-285
- Basic box 350, 284
- Basic box 350 with screed protection cover, 284-285
- BEF/F floor covering cassette, 320
- Blanking cover, 403
- Blanking cover for service outlets and cassettes, 357
- Blanking lid, 277, 291, 352
- Blanking lid 250-3 for GES2, 215
- Blanking lid 250-3 for GES4, 215
- Blanking lid 250-3 for GES6, 215
- Blanking lid 250-3 for GES9, 215
- Blanking lid 250-3 for GESR4, 215
- Blanking lid 250-3 for GESRM2, 215
- Blanking lid 250-3 for Telitank, 214
- Blanking lid 350-3 for GES4, 219
- Blanking lid 350-3 for GES6, 219
- Blanking lid 350-3 for GES9, 219
- Blanking lid 350-3 for GESR4, 219
- Blanking lid 350-3 for GESR7, 219
- Blanking lid 350-3 for GESR9, 219
- Blanking lid 350-3 for GESRM2, 219
- Blanking lid 350-3 for Telitank, 218
- Blanking lid DUG350-3R9 for GRAF9, 310
- Blanking lid for GES4, 400 mm, 244
- Blanking lid for GES4, 800 mm, 244
- Blanking lid for GES6, 400 mm, 244
- Blanking lid for GES6, 800 mm, 244
- Blanking lid for GES9, 400 mm, 244
- Blanking lid for GES9, 800 mm, 244
- Blanking lid for GESR9, 400 mm, 245
- Blanking lid for GESR9, 800 mm, 244
- Blanking lid for heavy-duty application of GRAF9, 310
- Blanking lid for Telitank mounting, 277
- Blanking lid for Telitank top, 400 mm, 243
- Blanking lid for Telitank top, 800 mm, 243
- Blanking lid, blank, 800 mm, 243
- Blanking lid, blank, locking, 800 mm, 243
- Blanking lid, branch trunking, 295
- Blanking lid, external corner, 291
- Blanking lid, heavy-duty 250-3/4, 215
- Blanking lid, heavy-duty 250-3R4, 216
- Blanking lid, heavy-duty 350-3/4, 220
- Blanking lid, heavy-duty 350-3/9, 220
- Blanking lid, heavy-duty 350-3R4, 220
- Blanking lid, heavy-duty 350-3R7, 220
- Blanking lid, heavy-duty 350-3R9, 220
- Blanking lid, internal corner, 291
- Blanking lid, T branch, 291
- Blanking lid, T junction connection piece, 295
- Blind cover for dry-cleaned floors with floor covering, 374
- recess
- Blind cover for dry-cleaned floors without floor covering, 373
- recess
- Blind cover for wet-cleaned floors without floor covering, 374
- recess

B

- Blind lid for UZD250-3, 214
- Blind lid for UZD350-3, 218
- Blind lid, moisture-protected, for UZD250-3, 214
- Blind lid, moisture-protected, for UZD350-3, 218
- Blind plate, 277
- Blind plate for Telitank mounting opening, 221
- Bolt tie, 212

C

- Cable outlet, raised floors, 374
- Cable routing clip, 307
- Carpet protection frame, 277
- Cassettes, 243
- Ceiling fastening screw, 221
- Circular saw, 375
- Connection adapter, straight, connector part, 250
- Connection adapter, straight, socket part, 250
- Connection shackle, 206, 208, 210, 270, 272, 274, 280, 282
- Connector for supply trunking, 249
- Connector for trunking unit with brush bar, 249
- Connector part 3-pin, spring power connection, 392
- Connector part, 3-pin, screw connection, 392
- Connector part, 5-pin, screw connection, 393
- Construction set for 90° angle to left, height 40–140 mm, 242
- Construction set for 90° angle to left, height 40–240 mm, 242
- Construction set for 90° angle to right, height 40–140, 241 mm
- Construction set for 90° angle to right, height 40–240, 241 mm
- Construction set for trunking T branch and intersection, 241
- Cord outlet for frame cassette, 334
- Corner panel T4L/T8NL, vaulted inwards, 366
- Corner panel T4L/T8NL, vaulted outwards, 365
- Cover plate Telitank T12L, 366-367
- Cover plate Telitank T4B, 362-363
- Cover plate Telitank T4L/T8NL, 364-365
- Cover plates for mounting box GB2, 348-349
- Cover plates for mounting box GB3, 253-254, 350-351

D

- Data connection module with support plate, Cat. 5e, 402
- Data connection module with support plate, Cat. 5e., 402 shielded
- Data connection module with support plate, Cat. 6, 402
- Data connection module with support plate, Cat. 6., 403 shielded
- Data technology support, type A, 1/1 module width, 266, 313
- Data technology support, type B, 1/1 module width, 267, 314
- Data technology support, type C, 1/1 module width, 267, 314
- Data technology support, type EP, 1/1 module width, 267, 314
- Data technology support, type F, 1/1 module width, 267, 314
- Data technology support, type PA, 1/1 module width, 267, 314
- Device cover plates, 372
- Device support, 249
- Device support for CEE installation, 358
- Distributor block, 3-pole, 393
- Dome lid for dry-cleaned floors, 373
- Dome lid for wet-cleaned floors, 373
- Drill bit, 375
- Drilling template, 375
- DSSL heavy-duty support, 341, 343, 345
- Duct connection bracket (conductive), 212
- Duct end closure section, 206, 208, 210, 270, 272, 274
- Duct fastening strap, 212

E

- Earth conductor clamp, 221, 243, 249, 290, 294
- Encoding pin, 400
- Extension unit for GES4, height 100–150 mm, 238
- Extension unit for GES4, height 40–140 mm, 230

E

Extension unit for GES4, height 40–240 mm, 230
 Extension unit for GES4, height 60–110 mm, 238
 Extension unit for GES6, height 100–150 mm, 238
 Extension unit for GES6, height 40–140 mm, 230
 Extension unit for GES6, height 40–240 mm, 230
 Extension unit for GES6, height 60–110 mm, 238
 Extension unit for GES9, height 100–150 mm, 239
 Extension unit for GES9, height 40–140 mm, 230
 Extension unit for GES9, height 40–240 mm, 231
 Extension unit for GES9, height 40–70 mm, 238
 Extension unit for GES9, height 60–110 mm, 238
 Extension unit for GES9/55, 259, 262
 Extension unit for GESR9, height 100–150 mm, 239
 Extension unit for GESR9, height 40–140 mm, 231
 Extension unit for GESR9, height 40–240 mm, 231
 Extension unit for GESR9, height 40–70 mm, 239
 Extension unit for GESR9, height 60–110 mm, 239
 Extension unit for GESR9/55, 259, 262
 External corner, 248

F

Fastening clip, 280, 282
 FBA-B200 foam block, 407
 FBA-BV200 vacuum block, 407
 FBA-SP filler in a cartridge, 407
 Fibre optic coupling with support plate, 403
 Fillers and inlay plates for round service outlets, 307
 Fitter for height-adjustable cassette, 336
 Fixing bracket for Flexkanal, 302, 307
 Fixing bracket for Flexkanal in GESRM2, 382
 Flat seal, 242
 Flattener with hand protection, 212
 Floor covering contact profile, 242
 Floor covering protection frame, 277
 Frame cassette for cord outlet, RKS, nominal size 250-, 318
 3
 Frame cassette for cord outlet, RKS, nominal size 350-, 319
 3
 Frame cassette for inspection opening, RK, nominal, 318
 size 250-3
 Frame cassette for inspection opening, RK, nominal, 318
 size 350-3
 Frame cassette for tube body, RKF, nominal size 250-3, 319
 Frame cassette for tube body, RKF, nominal size 350-3, 319
 Frame seal, 221-222

G

GE2V service outlet, 376
 GES2 universal service outlet, 300
 GES2DB service outlet, 300
 GES4 universal service outlet, 300
 GES4DB service outlet, 300
 GES4M10 universal service outlet, 300
 GES4M10DB service outlet, 301
 GES6 universal service outlet, 301
 GES6DB service outlet, 301
 GES6M10 universal service outlet, 301
 GES6M10DB service outlet, 301
 GES9 universal service outlet, 302
 GES9M10 universal service outlet, 302
 GES9M10DB service outlet, 302
 GESR4 universal service outlet, 305
 GESR7 universal service outlet, 305
 GESR9 service outlet with carpet protection frame, 306
 GESR9 universal service outlet, 306
 GESR9/10 universal service outlet, 306
 GESRA7/10 service outlet, 306
 GESRA7D service outlet, 305
 GESRA7DM service outlet, 305
 GESRA9/10 service outlet, 306

G

GESRM2 service outlet with floor covering protection, 379-380
 frame for UZD/UDL
 GESRM2 service outlet with protective frame for raised, 379
 and cavity flooring
 GESRM2 service outlet with protective frame for, 378
 UZD/UDL
 Grid conductor extension, 302, 307, 320
 GTGRAF9 device support, 309

H

Heavy-duty blanking lid for round cassettes, 342-343
 Heavy-duty blanking lid for square cassettes, 344-345
 Heavy-duty frame cassette for tube body, RKFSL, load, 340
 class 1
 Heavy-duty frame cassette for tube body, RKFSL, load, 341
 class 2
 Heavy-duty frame cassette, blank, RKSL, load class 1, 340
 Heavy-duty frame cassette, blank, RKSL, load class 2, 340
 Height-adjustable cassette for inspection opening, RKN,, 321
 nominal size 4
 Height-adjustable cassette for inspection opening, RKN,, 321
 nominal size 9
 Height-adjustable cassette for inspection opening,, 327
 RKNUZD3, nominal size 4
 Height-adjustable cassette for inspection opening,, 327
 RKNUZD3, nominal size 9
 Height-adjustable cassette for inspection opening, RKR,, 323
 nominal size R4
 Height-adjustable cassette for inspection opening, RKR,, 323
 nominal size R7
 Height-adjustable cassette for inspection opening, RKR,, 323
 nominal size R9
 Height-adjustable cassette for inspection opening,, 330
 RKRNUZD3, nominal size R4
 Height-adjustable cassette for inspection opening,, 330
 RKRNUZD3, nominal size R7
 Height-adjustable cassette for inspection opening,, 330
 RKRNUZD3, nominal size R9
 Height-adjustable cassette for tube body, RKFN,, 322
 nominal size 4
 Height-adjustable cassette for tube body, RKFN,, 322
 nominal size 9
 Height-adjustable cassette for tube body, RKFNUZD3,, 328
 nominal size 4
 Height-adjustable cassette for tube body, RKFNUZD3,, 329
 nominal size 9
 Height-adjustable cassette for tube body, RKFR,, 324-325
 nominal size R4
 Height-adjustable cassette for tube body, RKFR,, 325
 nominal size R7
 Height-adjustable cassette for tube body, RKFR,, 325
 nominal size R9
 Height-adjustable cassette for tube body, RKFRNUZD3,, 332
 nominal size R4
 Height-adjustable cassette for tube body, RKFRNUZD3,, 332
 nominal size R7
 Height-adjustable cassette for tube body, RKFRNUZD3,, 332-333
 nominal size R9
 Height-adjustable cassette with cord outlet, RKS,, 321
 nominal size 4
 Height-adjustable cassette with cord outlet, RKS,, 321-322
 nominal size 9
 Height-adjustable cassette with cord outlet,, 327-328
 RKSNUZD3, nominal size 4
 Height-adjustable cassette with cord outlet,, 328
 RKSNUZD3, nominal size 9
 Height-adjustable cassette with cord outlet, RKSR,, 323-324
 nominal size R4
 Height-adjustable cassette with cord outlet, RKSR,, 324
 nominal size R7
 Height-adjustable cassette with cord outlet, RKSR,, 324
 nominal size R9
 Height-adjustable cassette with cord outlet,, 331
 RKSRNUZD3, nominal size R4
 Height-adjustable cassette with cord outlet,, 331
 RKSRNUZD3, nominal size R7
 Height-adjustable cassette with cord outlet,, 331
 RKSRNUZD3, nominal size R9

Alphabetical table of contents

H

- Height-adjustable heavy-duty cassette for tube body,, 344
RKFNSL
- Height-adjustable heavy-duty cassette for tube body,, 342
RKFRSL
- Height-adjustable heavy-duty cassette, blank, RKNSL, 344
- Height-adjustable heavy-duty cassette, blank, RKRSL, 342

I

- Identification plate, 406
- Inscription label, 254, 351
- Insertion nut, 271, 273, 275, 293, 296, 368
- Inspection cover for half post mounting, 304
- Installation duct with mounting openings, 270, 272, 274
- Installation duct, 2-draw, 280, 282
- Installation duct, 3-draw, 280, 282
- Installation duct, closed, 270, 272, 274
- Installation frame for combination of 2x and 2x Modul, 264, 311
45 devices
- Installation frame for combination of 3x and 1x Modul, 264, 311
45 devices
- Installation frame for four single Modul 45 devices, 264, 311
- Installation frame for three single Modul 45 devices, 264, 311
- Installation trunking with 200 mm width, 258, 261
- Installation trunking with 300 mm width, 258, 261
- Installation trunking with 400 mm width, 258, 261
- Installation trunking with 500 mm width, 258, 261
- Installation trunking with 600 mm width, 258, 261
- Internal corner, 248

J

- Junction and branch box, 276
- Junction box frame for box size 250, 286
- Junction box frame for box size 350, 286

L

- Levelling profile for UGD250-3, 329, 333
- Levelling profile for UGD350-3, 329, 333
- Levelling unit, 242
- Levelling unit for lid butt support, 259-260
- Levelling unit for lid butt support, height 100–175 mm, 232
- Levelling unit for lid butt support, height 170–245 mm, 232
- Levelling unit for lid butt support, height 40–70 mm, 232
- Levelling unit for lid butt support, height 60–110 mm, 232
- Lid blind plate for rectangular mounting opening, 221
- Lid blind plate for round mounting opening, 221
- Lid butt seal, 249
- Lid butt seal for trunking width 200 and 300 mm, 232, 240, 259, 262
- Lid butt support for trunking width 400, 500 and 600 mm, 232, 240,
259, 262
- Lifting tool, 245
- Lifting tools, 335
- LS switch mounting support for installation in mounting, 357
boxes

M

- Modul 45 data technology for connection modules with, 402
support plate
- Modul 45connect connector, 250, 386
- Modul 45connect connector part adapter, 386
- Modul 45connect protective contact socket, 250, 386
- Modul 45connect strain relief, 252, 386
- Module support for four Modul 45 devices, system, 352
length 208 mm
- Module support for Modul 45 devices, 386
- Module support for three Modul 45 devices, system, 352
length 165 mm
- Module support with protective housing for Modul 45, 254, 353
devices
- Mounting box GB2, 348
- Mounting box GB2 with base perforation, 348
- Mounting box GB3, 253, 349

M

- Mounting box GB3 with base perforation, 349-350
- Mounting box insert for sloping installation of a Modul, 352
45 device
- Mounting box, Telitank T4L, 363
- Mounting lid, 292, 373
- Mounting lid, branch trunking, 295
- Mounting plate for the installation of data sockets in, 381
GESRM2
- Mounting plate for the installation of data sockets in, 265, 312
- System 55 module supports
- Mounting set for UZD250-3, 320, 341
- Mounting set for UZD350-3, 320, 341
- Mounting support for the installation of data sockets in, 376
GE2V
- Mounting support system for data technology, 354
connection sockets
- MT4 module support for OKB, 250

O

- OBO anchors, 212
- OBO knock-in anchors, 212
- OKA trunking end piece, 260, 262
- OKB supply trunking, 248
- On-floor branch trunking, 294
- On-floor installation trunking, trunking height 40 mm, 290
- On-floor installation trunking, trunking height 70 mm, 290
- On-floor installation trunking, trunking height 75 mm, 290

P

- Partition for module support, 353
- Partition Telitank T12L, 368
- Partition Telitank T4B, 363
- Partition Telitank T4L/T8NL, 365
- Protective contact socket, 0°, 265-266, 312-313, 398
- Protective contact socket, 33°, 266, 313, 353, 398
- Protective contact sockets, 33°, 255
- Protective housing for module support, 352-353
- Pyrosit cartridge pistol, 406
- Pyrosit FBS90 fire protection foam, 406
- Pyrosit fire protection kit, 406
- Pyrosit mixer pipe set, 406

Q

- Quick release aid, 221

R

- Raised ring, 372
- Ready-for-connection module support MT3, 387
- Ready-for-connection module support MT4, 387
- Ready-for-connection module support MT4 with surge, 387
protection
- Ready-for-connection mounting box GB2, 387
- Ready-for-connection mounting box GB2 with surge, 388
protection
- Ready-for-connection mounting box GB3, 388
- Ready-for-connection mounting box GB3 with surge, 388-389
protection
- Reconstruction set, 308
- RKNEV levelling unit, 322, 326
- RKNEV levelling units, 343, 345

S

- S990 cover frame, 365
- S990 cover frame with inscription label, 365
- Saw blade, 375
- Screed anchor, 242
- Screed protection cover, 394
- Separating retainer, 240, 249, 254, 351
- Separating retainer for module support, vertical, 265, 312
- Service outlet lid, 292
- Service outlet, round, for screed height 55 mm, 264, 311

S

Service outlet, square, for screed height 55 mm, 264, 311
 Service outlet, wet-cleaned with floor covering, 309
 protection frame
 Side profile for AIKA (spare part), 296
 Side profile for AIKU (spare part), 293
 Side profile for AIKU and AIKA, short length (spare part), 293, 296
 Snap-in data connection module, Cat. 5e, shielded, 357, 382
 Snap-in data connection module, Cat. 5e, unshielded, 356, 381
 Snap-in data connection module, Cat. 6, shielded, 357, 382
 Snap-in data connection module, Cat. 6, unshielded, 357, 382
 Snap-in modules, 377
 Socket section 3-pin, screw connection, 392
 Socket section 3-pin, spring power connection, 393
 Socket section 5-pin, screw connection, 393
 Socket with earthing pin, 0°, 399
 Socket with earthing pin, 0°, encoded version, 399
 Socket with earthing pin, 33°, 399-400
 Socket with earthing pin, 33°, encoded version, 400
 Socket, Danish standard, Modul 45, 0°, 401
 Socket, Swiss standard, Modul 45, 400
 Stacking aid for UZD/UGD250-3 with height 70–125, 213-214 mm
 Stacking aid for UZD/UGD350-3 with height 70–125, 217-218 mm
 Stacking aid for UZD250-3 with height 115–170 mm, 214
 Stacking aid for UZD250-3 with height 165–220 mm, 214
 Stacking aid for UZD350-3 with height 115–170 mm, 218
 Stacking aid for UZD350-3 with height 165–220 mm, 218
 Strain relief, 351, 368
 Strain relief for mounting support, 354
 Strain relief T4B and T12L, 368
 Support, 280, 282
 Support plate for mounting support, 354-356
 Surge protection module for module support MT3 and, 401
 MT4
 Surge protection module for mounting box GB2 and, 401
 GB3

T

T piece, 248
 T shaped distributor block, 3-pole, 393
 TAE telephone connection socket system, 402
 Telitank adapter for installation of Modul 45 under S990, 363
 cover, single
 Telitank adapter for installation of Modul 45 under S990, 364
 cover, triple
 Telitank T12L, 366
 Telitank T4B, 362
 Telitank T4L, 363
 Telitank T8NL, 363
 Threaded sleeve for height-adjustable cassette, 335
 Threaded sleeves for frame cassettes, 335
 Trunking end cap, 293
 Trunking end cap, branch trunking, 296
 Trunking end piece, 248
 Trunking end piece, height 40–140 mm, 241
 Trunking end piece, height 40–240 mm, 241
 Trunking separating retainer, 290, 294
 Trunking separating retainer for trunking height 75 mm, 290
 Trunking unit for GES4, height 100–150 mm, 235
 Trunking unit for GES4, height 40–140 mm, 227
 Trunking unit for GES4, height 40–240 mm, 227
 Trunking unit for GES4, height 60–110 mm, 235
 Trunking unit for GES6, height 100–150 mm, 236
 Trunking unit for GES6, height 40–140 mm, 228
 Trunking unit for GES6, height 40–240 mm, 228
 Trunking unit for GES6, height 60–110 mm, 235
 Trunking unit for GES9, height 100–150 mm, 236
 Trunking unit for GES9, height 40–140 mm, 228
 Trunking unit for GES9, height 40–240 mm, 228
 Trunking unit for GES9, height 40–70 mm, 236

T

Trunking unit for GES9, height 60–110 mm, 236
 Trunking unit for GESR9, height 100–150 mm, 237
 Trunking unit for GESR9, height 40–140 mm, 229
 Trunking unit for GESR9, height 40–240 mm, 229
 Trunking unit for GESR9, height 40–70 mm, 237
 Trunking unit for GESR9, height 60–110 mm, 237
 Trunking unit for Telitank structure, height 100–150 mm, 235
 Trunking unit for Telitank structure, height 40–140 mm, 227
 Trunking unit for Telitank structure, height 40–240 mm, 227
 Trunking unit for Telitank structure, height 40–70 mm, 234
 Trunking unit for Telitank structure, height 60–110 mm, 234
 Trunking unit with brush bar, 248
 Trunking unit, blank, height 100–150 mm, 233
 Trunking unit, blank, height 40–140 mm, 226
 Trunking unit, blank, height 40–240 mm, 226
 Trunking unit, blank, height 40–70 mm, 233
 Trunking unit, blank, height 60–110 mm, 233
 Trunking unit, blank, locking, height 100–150 mm, 234
 Trunking unit, blank, locking, height 40–140 mm, 226
 Trunking unit, blank, locking, height 40–240 mm, 226
 Trunking unit, blank, locking, height 40–70 mm, 233
 Trunking unit, blank, locking, height 60–110 mm, 234
 Tube body for frame cassette and height-adjustable, 334
 cassette
 Tube body for GRAF9 (spare part), 310

U

UDHome4 service outlet, 383
 UDHome9 service outlet, 383
 UGD250-3 for rectangular flush-mount units, for screed, 213
 height 70–125 mm
 UGD250-3 for round flush-mount units, for screed, 213
 height 70–125 mm
 UGD350-3 for rectangular flush-mount units, for screed, 217
 height 70–125 mm
 UGD350-3 for round flush-mount units, for screed, 217
 height 70–125 mm
 Underfloor box cover for box size 250, 286
 Underfloor box cover for box size 350, 286
 Underfloor box UGD250-3 for GES9/55, 263
 Underfloor box UGD350-3 for GES9/55, 263
 Underfloor box UGD350-3 for GESR9/55, 263
 Underfloor installation duct, 2-compartment, 206, 208, 210
 Underfloor installation duct, 3-compartment, 206, 208, 210
 Underfloor outlet box for GESRM2 mounting, 380
 Underfloor outlet box UDL, 372
 Underfloor outlet for cavity floor mounting, 372
 Underfloor outlet for duct mounting, 372
 Underfloor outlet for raised floor mounting, 372
 UVS power supply for heavy current with fixed, 389
 connection
 UVS power supply for heavy current with plug, 389-390
 connection
 UZD250-3 for screed height 115–170 mm, 213
 UZD250-3 for screed height 165–220 mm, 213
 UZD250-3 for screed height 70–125 mm, 213
 UZD250-3 with pipe entry for screed height 70–125 mm, 213
 UZD350-3 for screed height 115–170 mm, 217
 UZD350-3 for screed height 165–220 mm, 217
 UZD350-3 for screed height 70–125 mm, 217
 UZD350-3 with pipe entry for screed height 70–125 mm, 217

V

Vertical bend, three-compartment, 207, 209, 211, 270, 272, 274, 281,
 283
 Vertical bend, two-compartment, 206, 208, 210, 270, 272, 274, 281-
 282

W

Wall plate, 407

Alphabetical table of contents

Z

- ZES4 inspection cover, 303
- ZES6 inspection cover, 303
- ZES9 inspection cover, 303
- ZES9/10 inspection cover, 303
- ZESR4 inspection cover, 308
- ZESR7 inspection cover, 308
- ZESR9 inspection cover, 308
- ZESRA7 inspection cover, 308

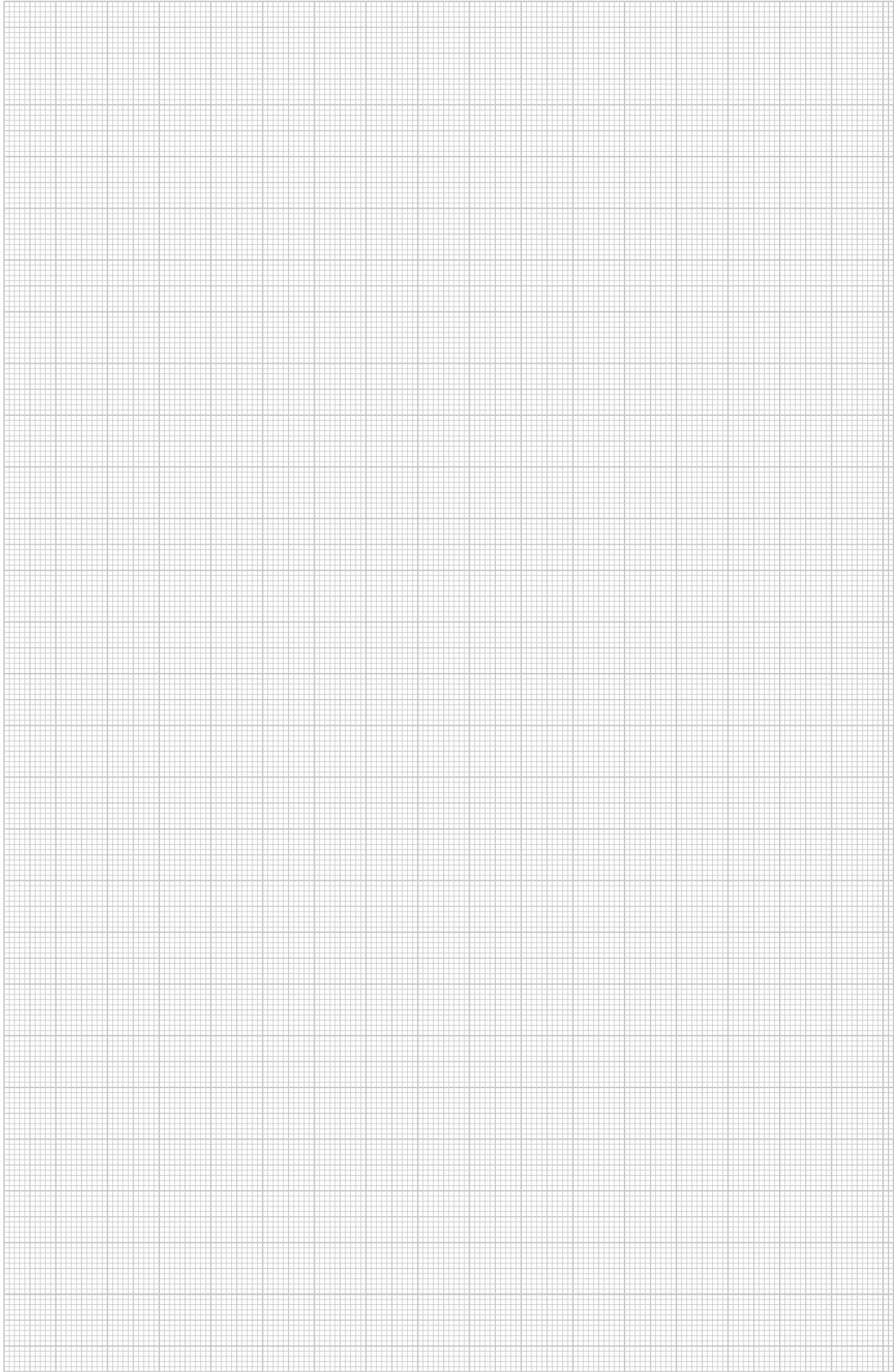

Numeric directory

Structure of the EAN number: Country code **40**

Manufacturer code **1219** (for articles beginning with **0: 1010**)

Individual EAN-C **5647589**

EAN-C.	Art. no.	Price	Page	EAN-C.	Art. no.	Price	Page	EAN-C.	Art. no.	Price	Page	EAN-C.	Art. no.	Price	Page
5669197	2351 05 6	/100 pc.	212	5122807	6108 13 0	/pc.	251	6471072	6117 01 8	/pc.	266	5675112	6117 38 1	/pc.	401
5229513	2351 06 4		212	5122814	6108 13 1		251	6458899	6117 02 3		266	5675167	6117 38 7		401
				5122821	6108 13 2		251	6645077	6117 02 5		266	5675211	6117 39 3		402
		/pc.		5122869	6108 13 3		251	6458950	6117 02 7		266	6117499	6117 40 6		403
5851417	3031 50 0		212	5122876	6108 13 4		251	6597376	6117 02 9		266	6117550	6117 41 4		403
		/100 pc.		5122883	6108 13 5		251	6459018	6117 04 1		255	6215713	6117 42 8		402
				5122920	6108 13 6		251	6459070	6117 04 3		255	6215959	6117 43 0		402
5851059	3105 01 6		212	5122937	6108 13 7		251	6459131	6117 04 5		255				
5851110	3105 02 4		212	5122944	6108 13 8		251	6459377	6117 04 7		255	6237319	6117 74 0		403
5851172	3105 03 2		212	5122982	6108 13 9		251	6213139	6117 04 9		398				
				5123064	6108 15 0		251	6459551	6117 05 2		255				
5963929	3498 10 7		212	5123101	6108 15 1		251	6459612	6117 05 4		255	5696896	6119 20 2		266
				5123118	6108 15 2		251	6459674	6117 05 6		255	5696957	6119 20 8		267
		/pc.		5123125	6108 15 3		251	6459735	6117 05 8		255	5696988	6119 21 4		267
				5123163	6108 15 4		251	6213191	6117 06 0		398	5697015	6119 22 0		267
5613596	5092 47 2		401	5123170	6108 15 5		251	6459797	6117 06 3		255	5697046	6119 22 6		267
				5123187	6108 15 6		251	6459858	6117 06 5		255	5697077	6119 23 2		267
				5123224	6108 15 7		251	6459971	6117 06 7		255	5670865	6119 85 0		250
5364184	6106 67 7		399	5123231	6108 15 8		251	6460038	6117 06 9		255	5670872	6119 85 2		250
5364252	6106 68 7		399	5123248	6108 15 9		251	6213436	6117 07 1		398	5670889	6119 85 4		250
5364368	6106 69 7		399	5123286	6108 16 0		251					5670896	6119 85 6		250
5364436	6106 70 7		400	5123293	6108 16 1		251	5437925	6117 07 4		250	5670902	6119 85 8		250
5364504	6106 71 7		400	5123309	6108 16 2		251	5437932	6117 07 6		250	5670919	6119 86 0		250
5364597	6106 72 7		400	5123347	6108 16 3		251	5437949	6117 07 8		250				
5364610	6106 73 5		400	5123354	6108 16 4		251	5437970	6117 08 0		250				
				5123422	6108 17 5		252	5437987	6117 08 2		250	5149101	6288 70 4		221
				5123453	6108 17 6		252								
5120957	6107 00 2		365	5123460	6108 17 7		252	6460090	6117 10 2		399				
5121022	6107 05 2		365	5123477	6108 17 8		252	6460151	6117 10 4		399	5428190	7202 32 2		407
5121084	6107 10 2		365	5123484	6108 17 9		252	6460212	6117 10 6		399	5428206	7202 50 6		407
5121183	6107 15 2		365	5123514	6108 18 0		252	6460274	6117 10 8		399	5428220	7202 51 6		407
5121244	6107 20 2		365	5123521	6108 18 1		252	6460335	6117 11 1		399				
5121305	6107 25 2		365	5123538	6108 18 2		252	6460458	6117 11 3		399	5448259	7205 42 5		406
5699767	6107 80 1		401	5123545	6108 18 3		252	6188956	6117 11 5		399				
				5123552	6108 18 4		252	6189014	6117 11 7		399	5650904	7208 22 1		406
				5123569	6108 18 5		252	6189076	6117 12 3		399	5650911	7208 22 5		406
5122265	6108 00 0		389	5123576	6108 18 6		252	6189311	6117 12 5		399	5650928	7208 22 9		406
5122272	6108 00 5		389	5123590	6108 18 7		252	6189373	6117 12 7		399			/VPE	
5122289	6108 01 0		389	5123606	6108 18 8		252	6189618	6117 12 9		399	5650935	7208 23 3		406
				5123613	6108 18 9		252	6189793	6117 14 0		399				
5522997	6108 01 2		390	5124368	6108 45 0		252	6189854	6117 14 2		399				
5523000	6108 01 4		389	5124375	6108 45 1		252	6287291	6117 14 4		399			/pc.	
5523017	6108 01 6		390	5124382	6108 45 2		252	6287536	6117 14 6		399	5626824	7368 38 4		376
5273530	6108 05 0		392	5124429	6108 45 3		252	6213856	6117 14 8		399	6020652	7368 59 3		335
5273547	6108 05 1		392	5124436	6108 45 4		252	6460632	6117 15 1		400				
5273585	6108 05 2		393	5124443	6108 45 5		252	6538690	6117 15 3		400			/m	
5273592	6108 05 3		393	5124481	6108 45 6		252	6637218	6117 15 5		400	5088134	7400 00 8		280
				5124498	6108 45 7		252	6461059	6117 15 7		400	5088141	7400 01 2		280
5273608	6108 05 4		392	5124504	6108 45 8		252	6213917	6117 15 9		400	5088189	7400 01 6		282
5273646	6108 05 5		392	5124542	6108 45 9		252	6461110	6117 16 2		400	5088196	7400 02 0		282
5273653	6108 05 6		392	5124559	6108 46 0		252	6461233	6117 16 4		400	5088202	7400 02 4		280
5273660	6108 05 7		392	5124566	6108 46 1		252	6461356	6117 16 6		400	5088233	7400 02 8		280
				5124603	6108 46 2		252	6461530	6117 16 8		400	5088240	7400 03 2		282
5273707	6108 07 0		393	5124610	6108 46 3		252	6213979	6117 17 0		400	5088257	7400 03 6		280
5273714	6108 07 2		393	5124627	6108 46 4		252					5088264	7400 04 0		282
				5124733	6108 47 5		252	5438069	6117 19 0		250			/pc.	
5273721	6108 08 0		393	5124740	6108 47 6		252	5438090	6117 19 2		250	5088295	7400 06 0		284
5273769	6108 08 2		393	5124788	6108 47 7		252	5670933	6117 19 6		386	5088301	7400 06 4		285
5273776	6108 08 4		393	5124795	6108 47 8		252	5670940	6117 19 7		386	5088318	7400 06 8		284
5122326	6108 10 0		251	5124801	6108 47 9		252	5438113	6117 19 8		250	5088325	7400 07 2		284
5122333	6108 10 1		251	5124832	6108 48 0		252					5088356	7400 07 6		285
5122340	6108 10 2		251	5124849	6108 48 1		252	5008866	6117 20 0		400	5088363	7400 08 0		284
5122388	6108 10 3		251	5124856	6108 48 2		252					5088370	7400 08 4		284
5122395	6108 10 4		251	5124863	6108 48 3		252	5462231	6117 20 2		401	5088387	7400 08 8		284
5122401	6108 10 5		251	5124894	6108 48 4		252	5616016	6117 20 3		401	5088417	7400 09 2		285
5122449	6108 10 6		251	5124900	6108 48 5		252					5088424	7400 09 6		285
5122456	6108 10 7		251	5124917	6108 48 6		252	6180196	6117 20 5		252	5088431	7400 10 0		285
5122463	6108 10 8		251	5124924	6108 48 7		252					5088448	7400 10 4		285
5122500	6108 10 9		251	51											

Numeric directory

EAN-C.	Art. no.	Price	Page	EAN-C.	Art. no.	Price	Page	EAN-C.	Art. no.	Price	Page	EAN-C.	Art. no.	Price	Page
		/pc.				/pc.				/m				/pc.	
5088622	7400 14 0		286	5431466	7400 52 5		220	5094012	7402 00 8		240	5100072	7404 45 6		388
5088660	7400 14 4		286	5431497	7400 52 9		220			/pc.		5100089	7404 46 0		388
5614357	7400 14 7		286	5431503	7400 53 3		219	5094067	7402 04 0		244	5100126	7404 46 8		387
5088677	7400 14 8		286	5483311	7400 53 4		220	5094081	7402 04 8		244	5100133	7404 47 2		387
5088684	7400 15 2		286	5483328	7400 53 5		220	5094128	7402 05 6		244	5100140	7404 47 6		388
5088714	7400 15 6		286	5431510	7400 53 7		220	5094142	7402 06 4		244	5100171	7404 48 0		388
5088721	7400 16 0		286	5483335	7400 53 8		220	5094173	7402 06 8		244	5100263	7404 50 8		388
5088738	7400 16 4		286	5483342	7400 53 9		220					5100294	7404 51 2		389
5365563	7400 16 5		286	5431527	7400 54 1		220			/m		5100355	7404 52 8		388
5088745	7400 16 8		286	5483359	7400 54 2		220	5699545	7403 81 0		248	5100362	7404 53 2		389
5088783	7400 17 2		286	5483366	7400 54 3		220	5699552	7403 81 5		248	5100379	7404 53 6		388
5691051	7400 17 5		286	5431558	7400 54 5		220			/pc.		5100386	7404 54 0		388
5088790	7400 17 6		286	5431565	7400 54 9		219	5699569	7403 82 0		248	5100492	7404 56 8		388
5088806	7400 18 0		286	5434900	7400 55 9		221	5699576	7403 82 5		248	5100508	7404 57 2		388
5088844	7400 18 4		286	5431572	7400 57 3		214	5699583	7403 83 0		248	5681526	7404 63 0		387
5365570	7400 18 6		286	5431589	7400 57 7		218	5699590	7403 83 5		248	5681533	7404 63 2		387
5088851	7400 20 0		280	5431619	7400 58 9		214			/m		5681540	7404 63 4		387
5088868	7400 20 4		280	5431626	7400 59 7		218	5699606	7403 84 0		249	5681557	7404 63 6		387
5088905	7400 20 8		280	5090243	7400 60 0		277			/pc.		5681564	7404 63 8		387
5088912	7400 21 2		280	5434894	7400 61 3		214	5699637	7403 84 5		249			/m	
5088929	7400 21 6		280	5090304	7400 62 0		206	5699699	7403 85 0		249	5100676	7404 70 0		290
5088967	7400 22 0		280	5090335	7400 62 4		208	5699705	7403 85 5		249	5100683	7404 70 4		290
5088974	7400 22 4		280	5090342	7400 62 8		210	5699712	7403 86 0		249	5100720	7404 70 8		290
5691068	7400 22 7		280	5090359	7400 63 2		206	5699729	7403 87 0		250	5100737	7404 71 2		290
5088981	7400 22 8		280	5090366	7400 63 6		208			/m		5100744	7404 71 6		290
5089025	7400 23 2		280	5090397	7400 64 0		210	5098515	7403 90 0		270	5100782	7404 72 0		290
5089032	7400 23 6		280	5090403	7400 64 4		207	5098522	7403 90 4		272			/pc.	
5089049	7400 24 0		280	5090410	7400 64 8		209	5098553	7403 90 8		274	5100799	7404 75 0		293
5089087	7400 24 4		280	5090427	7400 65 2		211	5098560	7403 91 2		270	5100805	7404 75 4		293
5089094	7400 24 8		280	5090458	7400 65 6		207	5098577	7403 91 6		272	5100843	7404 75 8		293
5627395	7400 24 9		280	5090465	7400 66 0		209	5098584	7403 92 0		274	5100850	7404 76 2		293
5313717	7400 25 0		280	5090472	7400 66 4		211	5098614	7403 92 4		272	5100867	7404 76 6		293
5313724	7400 25 1		282	5090489	7400 66 8		270	5098621	7403 92 8		274	5100904	7404 77 0		293
5313731	7400 25 2		280	5090519	7400 67 2		272	5098638	7403 93 2		270	5100911	7404 77 4		293
5313748	7400 25 3		282	5090526	7400 67 6		274	5098645	7403 93 6		272	5100928	7404 77 8		293
5313779	7400 25 4		280	5090694	7400 74 0		320	5098676	7403 93 6		274	5100966	7404 78 2		293
5313786	7400 25 5		282	5090700	7400 74 4		320	5098683	7403 94 0		270	5100973	7404 78 6		293
5089148	7400 26 4		280	5090717	7400 74 8		320	5098690	7403 94 4		272	5100980	7404 79 0		293
5089155	7400 26 8		282	5090724	7400 75 2		320	5098706	7403 94 8		274	5101024	7404 79 4		293
5089162	7400 27 2		280	5090755	7400 75 6		320	5098737	7403 95 2		270	5149583	7404 79 8		292
5089209	7400 27 6		282	5090762	7400 76 0		320	5098744	7403 95 6		272	5149613	7404 80 2		292
5089216	7400 28 0		280	5090786	7400 76 8		373	5098751	7403 96 0		274			/m	
5089223	7400 28 4		282	5090830	7400 78 0		277	5098768	7403 96 4		272	5101031	7404 80 6		293
		/m		5090847	7400 78 4		221	5098799	7403 96 8		274			/pc.	
5089254	7400 30 0		206	5090878	7400 78 8		222	5098805	7403 97 2		270	5101048	7404 81 0		293
5089261	7400 30 4		208	5432845	7400 96 0		206	5098812	7403 97 6		272			/m	
5089278	7400 30 8		210	5432883	7400 96 2		208			/pc.		5101086	7404 81 4		296
5089285	7400 31 2		206	5432890	7400 96 4		210	5098829	7403 98 0		206	5101093	7404 81 6		290
5089315	7400 31 6		208	5432906	7400 96 6		206	5098850	7403 98 4		208	5101109	7404 82 0		290
5089322	7400 32 0		210	5432944	7400 96 8		208	5098867	7403 98 8		210	5101147	7404 82 4		290
5089339	7400 32 4		206	5432951	7400 97 0		210							/pc.	
5089346	7400 32 8		208	5432968	7400 97 2		206	5098874	7404 00 2		206	5101154	7404 82 8		295
5089377	7400 33 2		210	5433002	7400 97 4		208	5098881	7404 00 6		208	5101161	7404 83 2		295
5089384	7400 33 6		206	5433019	7400 97 6		210	5098911	7404 01 0		210	5101208	7404 83 6		295
5089391	7400 34 0		208	5433026	7400 98 0		212	5098928	7404 01 4		206	5101215	7404 84 0		295
5089407	7400 34 4		210				243	5098935	7404 01 8		208	5101222	7404 84 4		295
		/pc.		5093510	7401 87 0		243	5098942	7404 02 2		210	5101260	7404 84 8		295
5483250	7400 41 8		215	5093602	7401 89 8		243	5098973	7404 02 6		277	5101277	7404 85 2		295
5483267	7400 42 0		215	5093640	7401 90 4		243	5098980	7404 03 0		277	5101284	7404 85 6		295
5483274	7400 42 2		215	5093664	7401 91 2		243	5098997	7404 03 4		277	5101321	7404 86 0		295
5434856	7400 43 1		218	5093701	7401 92 0		243	5099000	7404 03 8		277	5101338	7404 86 4		296
5431220	7400 45 5		215				240	5099154	7404 10 0		270	5101345	7404 86 8		296
5431251	7400 45 9		215	5093817	7401 96 0		240	5099161	7404 10 4		270	5101383	7404 87 0		296
5431268	7400 46 3		215	5093824	7401 96 4		240	5099178	7404 10 8		276			/m	
5431275	7400 46 7		215	5093831	7401 96 8		240	5099185	7404 11 2		276	5101390	7404 87 4		294
5431282	7400 47 1		215	5093848	7401 97 2		240	5099215	7404 11 6		276	5101406	7404 87 8		294
5431329	7400 47 5		216	5093879	7401 97 6		240			/m		5101444	7404 88 2		294
5431336	7400 47 9		216	5093886	7401 98 0		240	5099338	7404 22 0		242			/pc.	
5431343	7400 48 3		216	5093893	7401 98 4		240					5101451	7404 88 6		291
5431350	7400 48 7		220	5093909	7401 98 8		240	5099871	7404 40 0		394	5101468	7404 89 0		291
5431367	7400 49 1		220	5093930	7401 99 2		240	5099888	7404 40 4		394	5101505	7404 89 4		291
5431374	7400 49 5		220	5093947	7401 99 6		240	5099895	7404 40						

Numeric directory

Structure of the EAN number: Country code **40**

Manufacturer code **1219** (for articles beginning with **0: 1010**)

Individual EAN-C **5647589**

EAN-C.	Art. no.	Price	Page	EAN-C.	Art. no.	Price	Page	EAN-C.	Art. no.	Price	Page	EAN-C.	Art. no.	Price	Page
		/pc.				/pc.				/pc.				/pc.	
5101680	7404 92 8		291	5104285	7405 55 2		305	5106784	7406 10 4		341	5108481	7406 46 6		323
5101697	7404 93 2		291	5104322	7405 55 6		305	5106807	7406 11 2		341	5108528	7406 47 4		342
5101703	7404 93 6		291	5104339	7405 56 0		305	5106845	7406 11 6		341	5108535	7406 47 8		342
5101741	7404 94 0		291	5104384	7405 56 8		305	5106852	7406 12 0		341	5108542	7406 48 2		323
5101758	7404 94 4		291	5104391	7405 57 2		305	5106869	7406 12 4		341	5108573	7406 48 6		323
5101765	7404 94 8		291	5104407	7405 57 6		305	5106913	7406 13 2		341	5108634	7406 50 2		319
5101819	7404 95 6		292	5104445	7405 58 0		306	5107026	7406 15 2		319	5108641	7406 50 6		319
5101826	7404 96 0		292	5104452	7405 58 4		379	5107033	7406 15 6		319	5108658	7406 51 0		319
5101864	7404 96 4		292	5104506	7405 59 2		380	5107040	7406 16 0		319	5108719	7406 52 6		319
5101888	7404 97 2		292	5104513	7405 59 6		378	5107088	7406 16 4		319	5108726	7406 53 0		319
5101925	7404 97 6		292	5104636	7405 62 0		379	5107095	7406 16 8		319	5108757	7406 53 4		319
5101932	7404 98 0		292	5104681	7405 62 8		380	5107101	7406 17 2		319	5108764	7406 53 8		318
5101949	7404 98 4		292	5104698	7405 63 2		378	5107149	7406 17 6		319	5108771	7406 54 2		318
5101987	7404 98 8		292	5104759	7405 64 4		379	5107156	7406 18 0		319	5108788	7406 54 6		318
5101994	7404 99 2		291	5104810	7405 65 6		380	5107262	7406 20 0		319	5108795	7406 55 0		318
5102007	7404 99 6		291	5104827	7405 66 0		378	5107279	7406 20 4		319	5108801	7406 55 4		318
				5104926	7405 67 6		379	5107286	7406 20 8		319	5108818	7406 55 8		318
5102045	7405 00 0		291	5104988	7405 68 8		379	5107323	7406 21 2		319	5108825	7406 56 2		321
5102052	7405 00 4		291	5105053	7405 70 8		378	5107330	7406 21 6		319	5108863	7406 56 6		321
5102069	7405 00 8		291	5385721	7405 72 1		378	5107347	7406 22 0		319	5108870	7406 57 0		321
5102106	7405 01 2		291	5385738	7405 72 2		379	5107385	7406 22 4		319	5108887	7406 57 4		321
5674436	7405 03 7		264	5416029	7405 72 3		380	5107392	7406 22 8		319	5108924	7406 57 8		322
5674443	7405 03 9		264	5105169	7405 73 2		309	5107408	7406 23 2		322	5108931	7406 58 2		322
5674450	7405 04 7		264	5105176	7405 73 6		309	5107446	7406 23 6		322	5109006	7406 59 8		321
5674467	7405 04 9		264	5105183	7405 74 0		309	5107453	7406 24 0		322	5109051	7406 60 2		321
5681373	7405 05 0		302	5105220	7405 74 4		309	5107460	7406 24 4		322	5109068	7406 60 6		324
5681380	7405 05 2		302	5105237	7405 74 8		309	5483397	7406 24 5		344	5109075	7406 61 0		324
5681397	7405 05 4		302	5105244	7405 75 2		309	5483403	7406 24 6		344	5109082	7406 61 4		323
5102113	7405 10 0		300	5105282	7405 75 6		309	5107507	7406 24 8		322	5109112	7406 61 8		323
5102120	7405 10 4		300	5105299	7405 76 0		309	5107514	7406 25 2		322	5109136	7406 62 6		324
5102168	7405 10 8		300	5105305	7405 76 4		309	5107521	7406 25 6		322	5109143	7406 63 0		324
5102175	7405 11 2		300	5105343	7405 76 8		309	5107569	7406 26 0		322	5109174	7406 63 4		324
5102182	7405 11 6		300	5105350	7405 77 2		309	5483410	7406 26 1		344	5109181	7406 63 8		324
5102229	7405 12 0		300	5105367	7405 77 6		309	5483427	7406 26 2		344	5109204	7406 64 6		324
5102236	7405 12 4		300	5105404	7405 78 0		309	5107637	7406 27 6		325	5109235	7406 65 0		324
5102243	7405 12 8		300	5105411	7405 78 4		309	5107644	7406 28 0		325	5109242	7406 65 4		324
5102410	7405 16 4		300	5105640	7405 84 4		318	5107699	7406 28 8		342	5109259	7406 65 8		324
5102427	7405 16 8		300	5105657	7405 84 8		318	5107705	7406 29 2		342	5525219	7406 68 0		304
5102465	7405 17 2		300	5105664	7405 85 2		318	5107743	7406 29 6		324	5525226	7406 68 2		304
5102472	7405 17 6		300	5105695	7405 85 6		318	5107750	7406 30 0		324	5525233	7406 68 4		304
5102533	7405 18 8		301	5105725	7405 86 8		318	5107767	7406 30 4		325	5525240	7406 69 0		304
5102540	7405 19 2		300	5105756	7405 87 2		318	5107798	7406 30 8		325	5525288	7406 69 2		304
5102588	7405 19 6		300	5105763	7405 87 6		318	5107804	7406 31 2		342	5525295	7406 69 4		304
5102595	7405 20 0		300	5105770	7405 88 0		318	5107811	7406 31 6		342	5109310	7406 71 2		303
5102601	7405 20 4		300	5105824	7405 89 2		340	5107828	7406 32 0		325	5109327	7406 71 6		303
5102649	7405 20 8		300	5105831	7405 89 6		340	5107866	7406 32 4		325	5109358	7406 72 0		303
5102847	7405 26 0		301	5105848	7405 90 0		340	5107873	7406 32 8		325	5109426	7406 74 0		303
5102885	7405 26 4		301	5105886	7405 90 8		340	5107880	7406 33 2		325	5109433	7406 74 4		303
5102892	7405 26 8		301	5105893	7405 91 2		340	5107989	7406 34 8		342	5109440	7406 74 8		303
5102908	7405 27 2		301	5105909	7405 91 6		340	5107996	7406 35 2		342	5109471	7406 75 2		303
5103066	7405 30 0		301	5105930	7405 92 0		340	5108009	7406 35 6		325	5109488	7406 75 6		303
5103073	7405 30 4		301	5105954	7405 92 8		340	5108047	7406 36 0		325	5109495	7406 76 0		303
5103080	7405 30 8		301	5105961	7405 93 2		340	5108054	7406 36 4		321	5109501	7406 76 4		303
5103110	7405 31 2		301	5105992	7405 93 6		340	5108061	7406 36 8		321	5109532	7406 76 8		303
5103127	7405 31 6		301	5106005	7405 94 0		340	5108108	7406 37 0		321	5109549	7406 77 2		308
5103134	7405 32 0		301	5106029	7405 94 8		340	5108115	7406 37 4		321	5109556	7406 77 6		308
5103424	7405 38 0		302	5106050	7405 95 2		340	5483458	7406 37 5		344	5109563	7406 78 0		308
5103431	7405 38 4		302	5106067	7405 95 6		340	5483465	7406 37 6		344	5109594	7406 78 4		308
5103684	7405 43 6		305	5106074	7405 96 0		340	5108122	7406 37 8		321	5109600	7406 78 8		308
5103721	7405 44 0		305	5106111	7405 96 8		340	5108160	7406 38 2		321	5109617	7406 79 2		308
5103738	7405 44 4		305					5108177	7406 38 6		321	5109624	7406 79 6		308
5103745	7405 44 8		305	5106258	7406 00 0		318	5108184	7406 39 0		321	5109655	7406 80 0		308
5103783	7405 45 2		305	5106265	7406 00 4		318	5483472	7406 39 1		344	5109679	7406 80 8		308
5103790	7405 45 6		305	5106302	7406 00 8		318	5483489	7406 39 2		344	5109686	7406 81 2		308
5103806	7405 46 0		305	5106319	7406 01 2		318	5108221	7406 39 4		322	5109716	7406 81 6		308
5103844	7405 46 4		305	5106388	7406 02 8		318	5108238	7406 39 8		322	5109723	7406 82 0		308
5103905	7405 47 4		306	5106425	7406 03 2		318	5108290	7406 41 4		323	5109730	7406 82 4		308
5103912	7405 47 8		306	5106432	7406 03 6		318	5108306	7406 41 8		323	5436669	7406 83 4		303
5103929	7405 48 2		306	5106449	7406 04 0		318	5108337	7406 42 2		342	5436676	7406 83 6		303
5103967	7405 48 6		306	5106548	7406 05 6		340	5108344	7406 42 6		342	5436683	7406 83 8		303
5104094	7405 51 2		306	5106555	7406 06 0		340	5108351	7406 43 0		323	5436713	7406 84 0		303
5104100	7405 51 6		306	5106562	7406 06 4		340	5108368	7406 43 4		323	5436720	7406 84 4		303
5104148	7405 52 0		306	5106616	7406 07 2		340	5108399	7406 43 8		323	5436737	7406 84 6		303
5104155	7405 52 4		306	5106623	7406 07 6		340	5108405	7406 44 2		323	5426080	7406 85 0		335
5104162	7405 52 8		306	5106661	7406 08 0		340	5108412	7406 44 6		342	5426097	7406 85 1		335
5104209	7405 53 2		306	5106678	7406 08 4		340	5108429	7406 45 0		342	5426103	7406 85 2		335
5104216	7405 53 6		306												

EAN-C.	Art. no.	Price	Page	EAN-C.	Art. no.	Price	Page	EAN-C.	Art. no.	Price	Page	EAN-C.	Art. no.	Price	Page
		/pc.				/pc.				/pc.				/pc.	
5426158	7406 85 9		335	5112662	7407 65 4		341	5114451	7408 19 6		367	5693482	7408 70 5		265
5426165	7406 86 0		335	5112679	7407 65 8		357	5114536	7408 20 4		367	5693499	7408 70 7		265
5426172	7406 86 1		335	5112686	7407 66 2		357	5114543	7408 20 8		368	5693505	7408 70 9		265
5426189	7406 86 2		335	5450771	7407 66 3		358	5114604	7408 22 0		362				
5426295	7406 86 5		335	5450788	7407 66 5		358	5114659	7408 22 8		362	5430964	7410 03 0		213
5426301	7406 86 6		335	5450825	7407 66 7		358	5114703	7408 23 6		362	5475507	7410 03 1		213
5426332	7406 87 0		335	5450832	7407 66 9		358	5114727	7408 24 4		362	5431633	7410 03 4		217
5426349	7406 87 1		335	5623472	7407 67 9		376	5114772	7408 25 2		362	5475545	7410 03 5		217
5109891	7406 92 8		372	5112730	7407 68 8		357	5114826	7408 26 0		362	5431640	7410 04 3		213
5109969	7406 94 8		336	5112839	7407 71 2		357	5114840	7408 26 8		363	5431671	7410 04 7		217
5109976	7406 95 2		336	5113027	7407 76 4		356	5114895	7408 27 6		363	5431688	7410 05 2		213
5110101	7406 99 2		373	5113034	7407 76 8		355	5114901	7408 28 0		363	5431695	7410 05 6		217
5110132	7406 99 6		373	5113072	7407 77 6		355	5114956	7408 28 8		362	5678724	7410 06 0		263
				5113089	7407 78 0		354	5114963	7408 29 2		362	5678762	7410 06 2		263
5110149	7407 00 0		373	5113096	7407 78 4		354	5115007	7408 29 6		363	5678779	7410 06 4		263
5110156	7407 00 4		373	5113102	7407 78 8		354	5115014	7408 30 0		363	5431701	7410 07 9		213
5110194	7407 01 2		374	5415978	7407 79 0		355	5115021	7408 30 4		363	5431732	7410 08 3		213
5110200	7407 01 6		374	5113133	7407 79 2		355	5115564	7408 41 2		364	5431749	7410 08 7		213
5110217	7407 02 0		374	5113140	7407 79 6		355	5115601	7408 41 6		363	5431756	7410 09 1		213
5110224	7407 02 4		374	5623489	7407 79 8		356	5115618	7408 42 0		366	5431763	7410 10 4		217
5110255	7407 02 8		374	5113157	7407 80 0		355	5115625	7408 42 4		366	5431770	7410 10 8		217
5110262	7407 03 2		374	5113164	7407 80 4		356	5115663	7408 42 8		365	5431787	7410 11 2		217
5110279	7407 03 6		374	5113195	7407 80 8		356	5115670	7408 43 2		365	5431794	7410 11 6		217
5110286	7407 04 0		374	5113201	7407 81 2		356	5115687	7408 43 6		364	5431800	7410 12 0		217
5110323	7407 04 8		277	5113218	7407 81 6		356	5115724	7408 44 0		364	5431817	7410 12 4		217
5110330	7407 05 2		254	5455806	7407 81 7		356	5115731	7408 44 4		364	5431824	7410 12 8		213
5110446	7407 07 6		221	5688624	7407 81 8		356	5115748	7408 44 8		364	5431855	7410 14 6		214
5110736	7407 15 2		221	5113225	7407 82 0		354	5115786	7408 45 2		364	5438595	7410 14 8		214
5110743	7407 15 6		221	5113256	7407 82 4		354	5115793	7408 45 6		364	5431862	7410 15 0		217
5110798	7407 16 0		221	5113263	7407 82 8		355	5115809	7408 45 8		364	5431879	7410 15 4		218
5110804	7407 16 4		221	5113270	7407 83 2		355	5115847	7408 46 0		364	5438601	7410 15 6		218
5110811	7407 16 8		221	5417965	7407 83 3		355	5115854	7408 46 4		364	5473275	7410 15 8		214
5110828	7407 17 2		221	5113287	7407 83 6		354	5115861	7408 47 0		364	5431886	7410 16 0		221
5110842	7407 18 0		221	5113294	7407 84 0		354	5115908	7408 47 4		364	5473282	7410 16 2		214
5110859	7407 18 4		307	5113300	7407 84 4		354	5115915	7408 47 8		364	5473299	7410 16 4		218
5110866	7407 18 8		307	5626855	7407 84 6		376	5115922	7408 48 2		365	5473305	7410 16 6		218
5110873	7407 19 2		307	5626862	7407 84 7		376	5115960	7408 48 6		365	5431916	7410 16 8		341
5110880	7407 19 6		307	5626879	7407 84 8		376	5115977	7408 49 0		365	5431923	7410 17 2		341
5110941	7407 21 2		307	5626886	7407 84 9		376	5115984	7408 49 4		363	5431930	7410 17 6		341
5110958	7407 21 6		307	5626893	7407 85 0		376	5116028	7408 49 8		363	5431947	7410 18 0		341
5110972	7407 22 4		348	5437154	7407 86 0		302	5116035	7408 50 2		310	5682134	7410 18 6		341
5111009	7407 22 8		348	5437161	7407 86 2		302	5116042	7408 50 6		310	5431954	7410 20 0		327
5111016	7407 23 2		253	5437192	7407 86 4		382	5116080	7408 51 0		334	5431961	7410 20 4		327
5111030	7407 24 0		253	5438694	7407 89 4		374	5116097	7408 51 4		334	5431978	7410 20 9		327
5111078	7407 24 8		253	5438700	7407 89 6		374	5116103	7408 51 8		334	5431985	7410 21 3		327
5111092	7407 25 6		254	5438717	7407 89 8		374	5116141	7408 52 2		334	5431992	7410 21 8		327
5111139	7407 26 4		253	5113645	7407 97 6		334	5116158	7408 52 6		334	5432005	7410 22 2		327
5111146	7407 26 8		253	5113676	7407 98 0		334	5116165	7408 53 0		334	5432012	7410 22 7		327
5111153	7407 27 2		254	5113683	7407 98 4		334	5116202	7408 53 4		334	5432029	7410 23 1		327
5111191	7407 28 0		254	5113690	7407 98 8		334	5116271	7408 55 0		308	5432036	7410 24 6		327
5111214	7407 28 8		348	5113706	7407 99 2		334	5116288	7408 55 4		380	5432043	7410 25 0		327
5111245	7407 29 2		348	5113737	7407 99 6		334	5116325	7408 55 8		380	5432050	7410 25 5		328
5111290	7407 30 0		349				351	5116332	7408 56 2		380	5432067	7410 25 9		328
5111344	7407 30 8		348	5113812	7408 02 0		373	5116349	7408 56 6		372	5432098	7410 26 4		328
5111351	7407 31 2		349	5113829	7408 02 4		373	5116387	7408 57 0		372	5432104	7410 26 8		328
5111412	7407 32 4		253	5113850	7408 02 8		373	5116400	7408 57 8		372	5432111	7410 27 3		328
5111429	7407 32 8		349	5113867	7408 03 2		373	5116448	7408 58 2		372	5432128	7410 27 7		328
5111450	7407 33 2		350	5113881	7408 04 0		373	5116462	7408 59 0		372	5432135	7410 29 2		328
5111467	7407 33 6		253	5113911	7408 04 4		373	5116509	7408 59 4		372	5432142	7410 29 6		328
5111481	7407 34 4		254	5113928	7408 04 8		373	5116523	7408 60 2		372	5432159	7410 30 1		328
5111528	7407 35 2		254	5113935	7408 05 2		373	5116578	7408 61 0		375	5432166	7410 30 5		328
5111542	7407 36 0		253	5113942	7408 05 6		373	5116585	7408 61 4		375	5432173	7410 31 0		329
5111801	7407 42 4		352	5113973	7408 06 0		373	5116615	7408 61 8		375	5432180	7410 31 4		329
5112280	7407 53 6		302	5113980	7408 06 4		373					5432210	7410 31 9		329
5112419	7407 56 4		309	5114055	7408 08 4		271	5116639	7408 62 6		335	5432227	7410 32 3		329
5112426	7407 56 8		307	5114062	7408 08 8		368					5432234	7410 33 8		330
5112433	7407 58 0		352	5114109	7408 09 6		366	5116646	7408 63 0		245	5432241	7410 34 2		330
5112440	7407 58 4		352	5114116	7408 10 0		366	5116677	7408 63 4		245	5432289	7410 34 7		330
5112457	7407 58 8		357	5114154	7408 10 8		366	5116684	7408 63 8		375	5432296	7410 35 1		330
5112464	7407 59 2		357	5114178	7408 11 6		366	5116691	740						

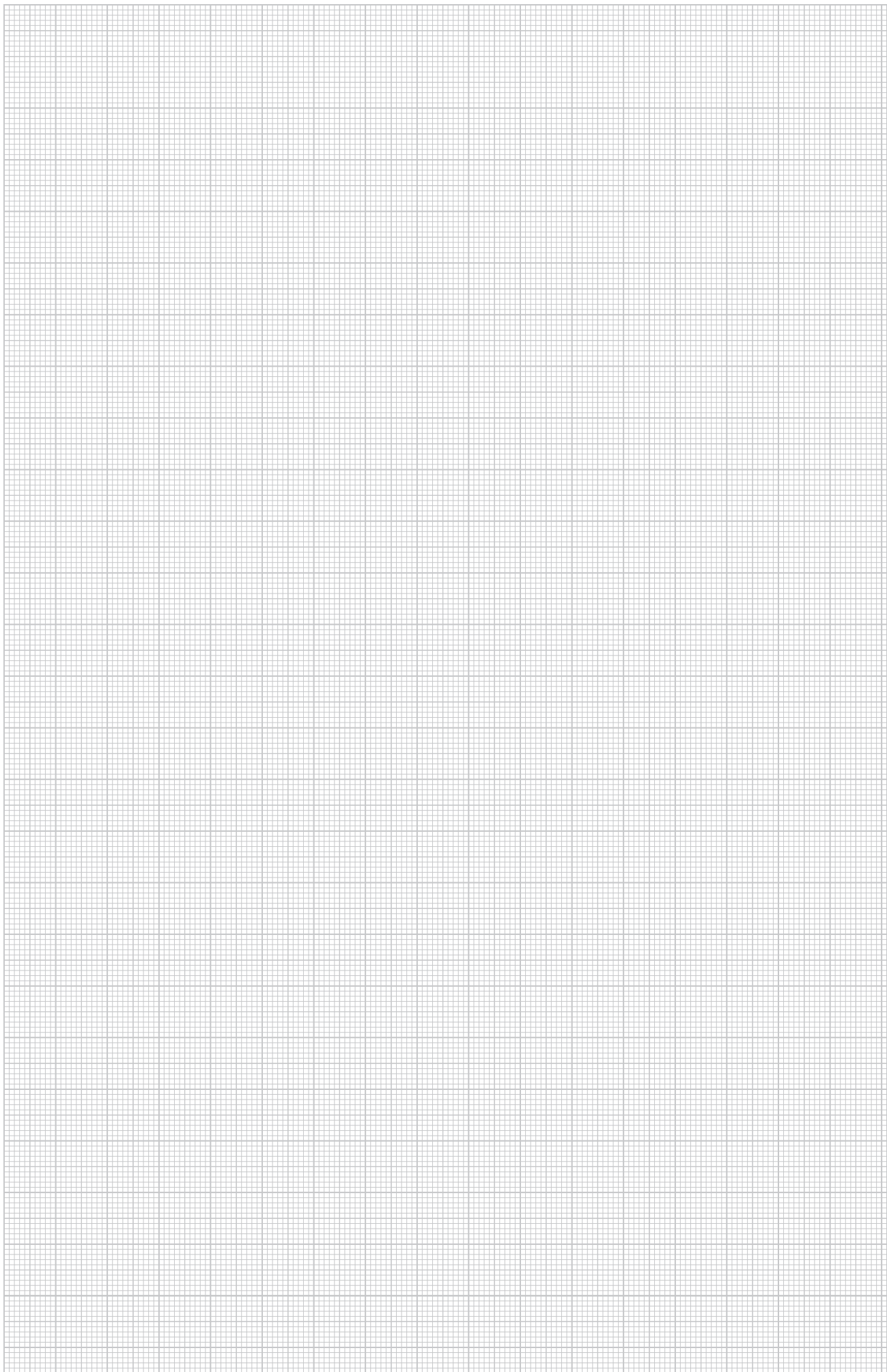

Type listing

Structure of the EAN number: Country code **40**

Manufacturer code **1219** (for articles beginning with **0: 1010**)

Individual EAN-C **5647589**

Type	Dimensions/Colour/Div.	EAN-C.	Art. no.	Price	Page	Type	Dimensions/Colour/Div.	EAN-C.	Art. no.	Price	Page
8AWR	/ St / G	5149101	6288 70 4	/pc.	221	AIKA AD 15040	800 150/ St / F	5101154	7404 82 8	/pc.	295
8AWR	/ St / G	5149101	6288 70 4		243	AIKA AD 20040	800 200/ St / F	5101161	7404 83 2		295
8AWR	/ St / G	5149101	6288 70 4		249	AIKA AD 25040	800 250/ St / F	5101208	7404 83 6		295
8AWR	/ St / G	5149101	6288 70 4		290						
8AWR	/ St / G	5149101	6288 70 4		294	AIKA D 15040	800 150/ St / F	5101215	7404 84 0		295
						AIKA D 20040	800 200/ St / F	5101222	7404 84 4		295
						AIKA D 25040	800 250/ St / F	5101260	7404 84 8		295
903 RB 15	15 10/ St	5851059	3105 01 6	/100 pc.	212	AIKA DAT 15040	800 150/ St / F	5101277	7404 85 2		295
903 RB 18	18 10/ St	5851110	3105 02 4		212	AIKA DAT 20040	800 200/ St / F	5101284	7404 85 6		295
903 RB 22	22 10/ St	5851172	3105 03 2		212	AIKA DAT 25040	800 250/ St / F	5101321	7404 86 0		295
910 SD 6X35	6 35/ PA	5669197	2351 05 6		212	AIKA ES 15040	150 224/ St / F	5101338	7404 86 4		296
910 SD 6X40	6 40/ PA	5229513	2351 06 4		212	AIKA ES 20040	200 274/ St / F	5101345	7404 86 8		296
						AIKA ES 25040	250 324/ St / F	5101383	7404 87 0		296
915 RBS M4	12/ St	5851417	3031 50 0	/pc.	212	AIKA U 15040	150 2400/ St / F	5101390	7404 87 4	/m	294
ADP-B RW0.5	Pure white	6117550	6117 41 4		403	AIKA U 20040	200 2400/ St / F	5101406	7404 87 8		294
ADP-B RW1	Pure white	6117499	6117 40 6		403	AIKA U 25040	250 2400/ St / F	5101444	7404 88 2		294
AGB2 0.7 1W1ORS		5099932	7404 41 6		388	AIKF AEA 15040	800 150/ St / F	5101451	7404 88 6	/pc.	291
AGB2 0.7 2W1OR		5099956	7404 42 4		387	AIKF AEA 20040	800 200/ St / F	5101468	7404 89 0		291
AGB2 0.7 2W1ORS		5099963	7404 42 8		388	AIKF AEA 20070	800 200/ St / F	5101505	7404 89 4		291
						AIKF AEA 25040	800 250/ St / F	5101512	7404 89 8		291
AGB2 1 1W1ORS2.5		5100003	7404 43 6		388	AIKF AEA 25070	800 250/ St / F	5101529	7404 90 2		291
						AIKF AEA 35075	800 350/ St / F	5101567	7404 90 6		291
AGB2 1 2W1OR2.5		5100010	7404 44 0		387						
AGB2 1 2W1ORS2.5		5100027	7404 44 4		388	AIKF D 15040	800 150/ St / F	5101574	7404 91 0		291
						AIKF D 15040T150	800 150/ St / F	5101581	7404 91 4		291
AGB2H1 1W1ORS		5100072	7404 45 6		388						
AGB2H1 1W1ORS2.5		5100089	7404 46 0		388	AIKF D 20040	800 200/ St / F	5101628	7404 91 6		291
						AIKF D 20040T150	800 200/ St / F	5101635	7404 92 0		291
AGB2H1 2W1OR		5100126	7404 46 8		387	AIKF D 20040T200	800 200/ St / F	5101642	7404 92 4		291
AGB2H1 2W1OR2.5		5100133	7404 47 2		387	AIKF D 20070	800 200/ St / F	5101680	7404 92 8		291
AGB2H1 2W1ORS		5100140	7404 47 6		388	AIKF D 25040	800 250/ St / F	5101697	7404 93 2		291
AGB2H1 2W1ORS2.5		5100171	7404 48 0		388	AIKF D 25040T150	800 250/ St / F	5101703	7404 93 6		291
						AIKF D 25040T250	800 250/ St / F	5101741	7404 94 0		291
AGB3 0.7 3W1OR		5100263	7404 50 8		388	AIKF D 25070	800 250/ St / F	5101758	7404 94 4		291
AGB3 0.7 3W1ORS		5100294	7404 51 2		389						
						AIKF D 35075	800 350/ St / F	5101765	7404 94 8		291
AGB3 1 3W1OR2.5		5100355	7404 52 8		388						
AGB3 1 3W1ORS2.5		5100362	7404 53 2		389	AIKF DAT 15040	800 150/ St / F	5101819	7404 95 6		292
						AIKF DAT 20040	800 200/ St / F	5101826	7404 96 0		292
AGB3H1 2W1ORS		5100379	7404 53 6		388	AIKF DAT 25040	800 250/ St / F	5101864	7404 96 4		292
AGB3H1 2W1ORS2.5		5100386	7404 54 0		388						
						AIKF DG2 2 2007	800 200/ St / F	5149583	7404 79 8		292
AGB3H1 3W1OR		5100492	7404 56 8		388	AIKF DG2 2 2507	800 250/ St / F	5149613	7404 80 2		292
AGB3H1 3W1OR2.5		5100508	7404 57 2		388	AIKF DG2 20070	800 200/ St / F	5101888	7404 97 2		292
						AIKF DG2 25070	800 250/ St / F	5101925	7404 97 6		292
AIK 6TW 40	2400/ St / FS	5101109	7404 82 0	/m	290	AIKF DG4 35075	400 350/ St / F	5101932	7404 98 0		292
AIK 6TW 40	2400/ St / FS	5101109	7404 82 0		294						
AIK 6TW 70	2400/ St / FS	5101147	7404 82 4		290	AIKF DG6 35075	400 350/ St / F	5101949	7404 98 4		292
						AIKF DG9 35075	400 350/ St / F	5101987	7404 98 8		292
AIK ESL 15040	150 187/ St / F	5100799	7404 75 0	/pc.	293						
AIK ESL 20040	200 237/ St / F	5100805	7404 75 4		293	AIKF IAE 25070	800 250/ St / F	5101994	7404 99 2		291
AIK ESL 20070	200 266/ St / F	5100843	7404 75 8		293						
AIK ESL 25040	250 287/ St / F	5100850	7404 76 2		293	AIKF IEA 15040	800 150/ St / F	5102007	7404 99 6		291
AIK ESL 25070	250 316/ St / F	5100867	7404 76 6		293	AIKF IEA 20040	800 200/ St / F	5102045	7405 00 0		291
AIK ESL 35075	350 421/ St / F	5100904	7404 77 0		293	AIKF IEA 20070	800 200/ St / F	5102052	7405 00 4		291
						AIKF IEA 25040	800 250/ St / F	5102069	7405 00 8		291
						AIKF IEA 35075	800 350/ St / F	5102106	7405 01 2		291
AIK ESR 15040	150 187/ St / F	5100911	7404 77 4		293						
AIK ESR 20040	200 237/ St / F	5100928	7404 77 8		293						
AIK ESR 20070	200 266/ St / F	5100966	7404 78 2		293						
AIK ESR 25040	250 287/ St / F	5100973	7404 78 6		293	AIKF SP	2400/ AI	5101031	7404 80 6	/m	293
AIK ESR 25070	250 316/ St / F	5100980	7404 79 0		293						
AIK ESR 35075	350 421/ St / F	5101024	7404 79 4		293	AIKU 15040	150 2400/ St / F	5100676	7404 70 0		290
AIK SP K	100/ AI	5101048	7404 81 0		293	AIKU 20040	200 2400/ St / F	5100683	7404 70 4		290
AIK SP K	100/ AI	5101048	7404 81 0		296	AIKU 20070	200 2400/ St / F	5100720	7404 70 8		290
						AIKU 25040	250 2400/ St / F	5100737	7404 71 2		290
AIK SP L	2400/ AI	5101086	7404 81 4	/m	296	AIKU 25070	250 2400/ St / F	5100744	7404 71 6		290
AIK TWL 75	2400/ St / F	5101093	7404 81 6		290	AIKU 35075	350 2400/ St / F	5100782	7404 72 0		290

08 UFS_Katalog_2010_Neuer_Stand / en / 25/02/2010 (LLEExport_00997)

Type	Dimensions/Colour/Div.	EAN-C.	Art. no.	Price	Page	Type	Dimensions/Colour/Div.	EAN-C.	Art. no.	Price	Page
AMT3 2WSVCG		5681526	7404 63 0	/pc.	387	BABN80 7011	Grey/ PA	5110255	7407 02 8	/pc.	374
AMT3 3WSVCG		5681533	7404 63 2		387	BABN80 8014	Sepia brown/ PA	5110286	7407 04 0		374
AMT4 2WS2ORVCG		5681557	7404 63 6		387	BABN80 9011	Graphite black/ PA	5110262	7407 03 2		374
AMT4 2WS2ORVCGS		5681564	7404 63 8		387	BAU E 7011	Grey/ PA	5110323	7407 04 8		277
AMT4 4WSVCG		5681540	7404 63 4		387	BEK F250-2 3	/ V2A	5090694	7400 74 0		320
						BEK F250-2 4	/ V2A	5090700	7400 74 4		320
						BEK F250-2 5	/ V2A	5090717	7400 74 8		320
ANT-2D RW1	Pure white	5675167	6117 38 7		401	BEK F350-2 3	/ V2A	5090724	7400 75 2		320
ANT-2E RW1	Pure white	5675112	6117 38 1		401	BEK F350-2 4	/ V2A	5090755	7400 75 6		320
ANT-3E RW1	Pure white	5675211	6117 39 3		402	BEK F350-2 5	/ V2A	5090762	7400 76 0		320
						BF 1	/ PC	5110330	7407 05 2		254
AR80 24	86/ AIG	5109891	7406 92 8		372	BF 1	/ PC	5110330	7407 05 2		351
AS 4	/ St / FS	5109969	7406 94 8		336	BL1	/ ST / FS	5301851	7428 50 0		212
AS 9	/ St / FS	5109976	7406 95 2		336	BTA-SKS S1 SW	Black	5438069	6117 19 0		250
ASH250-3 165220	330 80/ St / FS	5431855	7410 14 6		214	BT-F GST18i3p SW	Black	5273585	6108 05 2		393
ASH250-3 215270	330 80/ St / FS	5473275	7410 15 8		214	BT-F GST18i3p W	White	5273592	6108 05 3		393
ASH250-3 265320	330 130/ St / FS	5473282	7410 16 2		214						
ASH250-3 B115170	330 80/ St / FS	5431824	7410 14 2		213						
ASH250-3 B165220	330 130/ St / FS	5438595	7410 14 8		214						
ASH350-3 165220	430 80/ St / FS	5431879	7410 15 4		218	BT-S GST18i3p SW	Black	5273653	6108 05 6		392
ASH350-3 215270	430 80/ St / FS	5473299	7410 16 4		218	BT-S GST18i3p W	White	5273660	6108 05 7		392
ASH350-3 265320	430 130/ St / FS	5473305	7410 16 6		218	BT-S GST18i5p SW	Black	5273714	6108 07 2		393
ASH350-3 B115170	430 80/ St / FS	5431862	7410 15 0		217						
ASH350-3 B165220	430 130/ St / FS	5438601	7410 15 6		218	CST-SKS	Black/ PC	5364610	6106 73 5		400
ASM-C5		6235278	6117 33 7		402	DAT F	/ St / FS	5110446	7407 07 6		221
ASM-C5 G		6235155	6117 32 5		402	DAT F	/ St / FS	5110446	7407 07 6		277
ASM-C5 GS		5402428	6117 34 3		357	DBS 80	/ St / FS	5090786	7400 76 8		373
ASM-C5 GS		5402428	6117 34 3		377	DBS DUG	/ St / G	5434900	7400 55 9		221
ASM-C5 GS		5402428	6117 34 3		382						
ASM-C5 S		5402442	6117 34 7		356	DMG-2RM RW1	Pure white	5006947	6117 31 9		402
ASM-C5 S		5402442	6117 34 7		377						
ASM-C5 S		5402442	6117 34 7		381	DMS-2RM RW1	Pure white/ PC	5006848	6117 31 5		402
ASM-C6		6235339	6117 34 1		402	DSD2 200	200/ St / FS	5245339	7424 99 0		232
						DSD2 200	200/ St / FS	5245339	7424 99 0		240
ASM-C6 G		6235216	6117 32 9		403	DSD2 200	200/ St / FS	5245339	7424 99 0		262
						DSD2 200	200/ St / FS	5245339	7424 99 0		259
ASM-C6 GS		5402435	6117 34 5		357						
ASM-C6 GS		5402435	6117 34 5		377	DSD2 300	300/ St / FS	5245346	7424 99 2		232
ASM-C6 GS		5402435	6117 34 5		382	DSD2 300	300/ St / FS	5245346	7424 99 2		240
						DSD2 300	300/ St / FS	5245346	7424 99 2		262
ASM-C6 S		5402459	6117 34 9		357	DSD2 300	300/ St / FS	5245346	7424 99 2		259
ASM-C6 S		5402459	6117 34 9		377						
ASM-C6 S		5402459	6117 34 9		382	DSSL2 100 140	/ St / FS	5431923	7410 17 2		341
						DSSL2 100 140	/ St / FS	5431923	7410 17 2		343
						DSSL2 100 140	/ St / FS	5431923	7410 17 2		345
ASM-LWL K		6237319	6117 74 0		403						
						DSSL2 130 170	/ St / FS	5431930	7410 17 6		341
						DSSL2 130 170	/ St / FS	5431930	7410 17 6		343
BAB80 1019	Grey-beige/ PA	5110149	7407 00 0		373	DSSL2 130 170	/ St / FS	5431930	7410 17 6		345
BAB80 7011	Grey/ PA	5110101	7406 99 2		373	DSSL2 160 200	/ St / FS	5431947	7410 18 0		341
						DSSL2 160 200	/ St / FS	5431947	7410 18 0		343
BAB80 8014	Sepia brown/ PA	5110156	7407 00 4		373	DSSL2 160 200	/ St / FS	5431947	7410 18 0		345
BAB80 9011	Graphite black/ PA	5110132	7406 99 6		373	DSSL2 220 320	/ ST / FS	5682134	7410 18 6		341
BABF80 AK	/ Zn / Cu	5110194	7407 01 2		374	DSSL2 70 110	/ St / FS	5431916	7410 16 8		341
BABF80 AM	/ Zn / CuZn	5110200	7407 01 6		374	DSSL2 70 110	/ St / FS	5431916	7410 16 8		343
						DSSL2 70 110	/ St / FS	5431916	7410 16 8		345
BABF80 CR	/ Zn	5110217	7407 02 0		374						
BABF80 NI	/ Zn / N	5110224	7407 02 4		374	DSU2 400	400/ St / FS	5244073	7424 36 0		232
						DSU2 400	400/ St / FS	5244073	7424 36 0		259
						DSU2 400 10050	400 100-150 / St / FS	5245308	7424 98 0		240
BABN80 1019	Grey-beige/ PA	5110279	7407 03 6		374	DSU2 400 10050	400 100-150 / St / FS	5245308	7424 98 0		262

Type listing

Structure of the EAN number: Country code **40**

Manufacturer code **1219** (for articles beginning with **0: 1010**)

Individual EAN-C **5647589**

Type	Dimensions/Colour/Div.	EAN-C.	Art. no.	Price	Page	Type	Dimensions/Colour/Div.	EAN-C.	Art. no.	Price	Page
				/pc.						/pc.	
DSU2 400 4030	400 40-70 / St / FS	5245254	7424 94 0		240	DUG 350-3 4SL130	383 201/ St / FS	5483335	7400 53 8		344
DSU2 400 4030	400 40-70 / St / FS	5245254	7424 94 0		262	DUG 350-3 4SL70	383 201/ St / FS	5483311	7400 53 4		220
DSU2 400 6050	400 60-110 / St / FS	5245278	7424 96 0		240	DUG 350-3 4SL70	383 201/ St / FS	5483311	7400 53 4		344
DSU2 400 6050	400 60-110 / St / FS	5245278	7424 96 0		262	DUG 350-3 6	383 201/ St / FS	5431404	7400 50 9		219
						DUG 350-3 9	383 244/ St / FS	5431435	7400 51 3		219
DSU2 500	500 / St / FS	5244080	7424 36 2		232	DUG 350-3 9SL100	383 244/ St / FS	5483359	7400 54 2		220
DSU2 500	500 / St / FS	5244080	7424 36 2		259	DUG 350-3 9SL100	383 244/ St / FS	5483359	7400 54 2		345
DSU2 500 10050	500 100-150 / St / FS	5245315	7424 98 2		240	DUG 350-3 9SL130	383 244/ St / FS	5483366	7400 54 3		220
DSU2 500 10050	500 100-150 / St / FS	5245315	7424 98 2		262	DUG 350-3 9SL130	383 244/ St / FS	5483366	7400 54 3		345
DSU2 500 4030	500 40-70 / St / FS	5245261	7424 94 2		240	DUG 350-3 9SL70	383 244/ St / FS	5483342	7400 53 9		220
DSU2 500 4030	500 40-70 / St / FS	5245261	7424 94 2		262	DUG 350-3 9SL70	383 244/ St / FS	5483342	7400 53 9		345
DSU2 500 6050	500 60-110 / St / FS	5245285	7424 96 2		240	DUG 350-3 R4	383 215/ St / FS	5431442	7400 51 7		219
DSU2 500 6050	500 60-110 / St / FS	5245285	7424 96 2		262	DUG 350-3 R7	383 275/ St / FS	5431503	7400 53 3		219
						DUG 350-3 R9	383 305/ St / FS	5431565	7400 54 9		219
DSU2 600	600 / St / FS	5244110	7424 36 4		232	DUG 350-3 R9	383 305/ St / FS	5431565	7400 54 9		310
DSU2 600	600 / St / FS	5244110	7424 36 4		259	DUG 350-3 RM2	383 120/ St / FS	5620938	7400 50 2		219
DSU2 600 10050	600 100-150 / St / FS	5245322	7424 98 4		240	DUG 350-3R4SL100	383 215/ St / FS	5431466	7400 52 5		220
DSU2 600 10050	600 100-150 / St / FS	5245322	7424 98 4		262	DUG 350-3R4SL100	383 215/ St / FS	5431466	7400 52 5		343
DSU2 600 4030	600 40-70 / St / FS	5246428	7424 94 4		240	DUG 350-3R4SL130	383 215/ St / FS	5431497	7400 52 9		220
DSU2 600 4030	600 40-70 / St / FS	5246428	7424 94 4		262	DUG 350-3R4SL130	383 215/ St / FS	5431497	7400 52 9		343
DSU2 600 6050	600 60-110 / St / FS	5245292	7424 96 4		240	DUG 350-3R4SL70	383 215/ St / FS	5431459	7400 52 1		220
DSU2 600 6050	600 60-110 / St / FS	5245292	7424 96 4		262	DUG 350-3R4SL70	383 215/ St / FS	5431459	7400 52 1		343
						DUG 350-3R7SL100	383 275/ St / FS	5431527	7400 54 1		220
						DUG 350-3R7SL100	383 275/ St / FS	5431527	7400 54 1		343
DTG-2A RW1	Pure white/ pc	5696896	6119 20 2		266	DUG 350-3R7SL130	383 275/ St / FS	5431558	7400 54 5		220
DTG-2A RW1	Pure white/ pc	5696896	6119 20 2		313	DUG 350-3R7SL130	383 275/ St / FS	5431558	7400 54 5		343
						DUG 350-3R7SL70	383 275/ St / FS	5431510	7400 53 7		220
DTG-2B RW1	Pure white/ pc	5696957	6119 20 8		267	DUG 350-3R7SL70	383 275/ St / FS	5431510	7400 53 7		343
DTG-2B RW1	Pure white/ pc	5696957	6119 20 8		314	DUG 350-3R9SL100	383 305/ St / FS	5431367	7400 49 1		220
						DUG 350-3R9SL100	383 305/ St / FS	5431367	7400 49 1		310
DTG-2C RW1	Pure white/ pc	5696988	6119 21 4		267	DUG 350-3R9SL100	383 305/ St / FS	5431367	7400 49 1		343
DTG-2C RW1	Pure white/ pc	5696988	6119 21 4		314	DUG 350-3R9SL130	383 305/ St / FS	5431374	7400 49 5		220
						DUG 350-3R9SL130	383 305/ St / FS	5431374	7400 49 5		310
DTG-2EP RW1	Pure white/ pc	5697077	6119 23 2		267	DUG 350-3R9SL130	383 305/ St / FS	5431374	7400 49 5		343
DTG-2EP RW1	Pure white/ pc	5697077	6119 23 2		314	DUG 350-3R9SL70	383 305/ St / FS	5431350	7400 48 7		220
						DUG 350-3R9SL70	383 305/ St / FS	5431350	7400 48 7		310
DTG-2F RW1	Pure white/ pc	5697015	6119 22 0		267	DUG 350-3R9SL70	383 305/ St / FS	5431350	7400 48 7		343
DTG-2F RW1	Pure white/ pc	5697015	6119 22 0		314						
						DUG B 2	109 185/ St / FS	5110804	7407 16 4		221
DTG-2PA RW1	Pure white/ pc	5697046	6119 22 6		267						
DTG-2PA RW1	Pure white/ pc	5697046	6119 22 6		314	DUG B 4	205 205/ St / FS	5110811	7407 16 8		221
						DUG B 6	205 258/ St / FS	5110828	7407 17 2		221
DU 121	/ St / FS	5090830	7400 78 0		277						
						DUG B 9	247 247/ St / FS	5110842	7407 18 0		221
DU 122 E	189/ St / FS	5090243	7400 60 0		277						
						DUG B R4	219/ St / FS	5110736	7407 15 2		221
DU 250-2	282/ St / FS	5431572	7400 57 3		214						
						DUG B R7	279/ St / FS	5110743	7407 15 6		221
DU 350-2	383/ St / FS	5431589	7400 57 7		218						
						DUG B R9	309/ St / FS	5110798	7407 16 0		221
DUF 250-2	282/ St / FS	5431619	7400 58 9		214						
DUF 250-3DAT	282 100/ St / FS	5434894	7400 61 3		214	EA3 6	/ V2A	5245506	7425 14 0		242
						EP QR R7	/ AI	5110859	7407 18 4		307
DUG 250-3 2	282 105/ St / FS	5431220	7400 45 5		215	EP QR R9	/ AI	5110866	7407 18 8		307
DUG 250-3 4	282 201/ St / FS	5431251	7400 45 9		215	EP QR R9 10	/ AI	5110873	7407 19 2		307
DUG 250-3 4SL100	282 201/ St / FS	5483267	7400 42 0		215						
DUG 250-3 4SL100	282 201/ St / FS	5483267	7400 42 0		344	EP QR RA9 10	/ AI	5110880	7407 19 6		307
DUG 250-3 4SL130	282 201/ St / FS	5483274	7400 42 2		215						
DUG 250-3 4SL130	282 201/ St / FS	5483274	7400 42 2		344	FBA-B200	200 x 120 x 60	5428206	7202 50 6		407
DUG 250-3 4SL70	282 201/ St / FS	5483250	7400 41 8		215						
DUG 250-3 4SL70	282 201/ St / FS	5483250	7400 41 8		344	FBA-BV200	200 x 120 x 25	5428220	7202 51 6		407
DUG 250-3 6	282 201/ St / FS	5431268	7400 46 3		215						
DUG 250-3 9	282 244/ St / FS	5431275	7400 46 7		215	FBA-SP		5428190	7202 32 2		407
DUG 250-3 R4	282 215/ St / FS	5431282	7400 47 1		215						
DUG 250-3 RM2	282 120/ St / FS	5431381	7400 50 1		215	FBS90-K		5650928	7208 22 9		406
DUG 250-3R4SL100	282 215/ St / FS	5431336	7400 47 9		216						
DUG 250-3R4SL100	282 215/ St / FS	5431336	7400 47 9		342					/VPE	
DUG 250-3R4SL130	282 215/ St / FS	5431343	7400 48 3		216	FBS90-M		5650935	7208 23 3		406
DUG 250-3R4SL130	282 215/ St / FS	5431343	7400 48 3		342						
DUG 250-3R4SL70	282 215/ St / FS	5431329	7400 47 5		216					/pc.	
DUG 250-3R4SL70	282 215/ St / FS	5431329	7400 47 5		342	FBS90-P2		5650911	7208 22 5		406
						FBS90-S		5650904	7208 22 1		406
DUG 350-3 4	383 201/ St / FS	5431398	7400 50 5		219						
DUG 350-3 4SL100	383 201/ St / FS	5483328	7400 53 5		220						
DUG 350-3 4SL100	383 201/ St / FS	5483328	7400 53 5		344						
DUG 350-3 4SL130	383 201/ St / FS	5483335	7400 53 8		220	FD 250-2	/ MGUM	5090847	7400 78 4		221

08 UFS_Katalog_2010_Neuer_Stand / en / 25/02/2010 (LLEExport_00997)

Type	Dimensions/Colour/Div.	EAN-C.	Art. no.	Price	Page	Type	Dimensions/Colour/Div.	EAN-C.	Art. no.	Price	Page
FD 350-02	/ MGUM	5090878	7400 78 8	/pc.	222	GES RV	/ PA	5112280	7407 53 6	/pc.	302
FKH GES10	/ St / FS	5437161	7407 86 2		302	GES RV	/ PA	5112280	7407 53 6		307
FKH GES10	/ St / FS	5437161	7407 86 2		307	GES RV	/ PA	5112280	7407 53 6		320
FKH GES5	/ St / FS	5437154	7407 86 0		302	GES2 DB 1019	Grey-beige / PA	5102168	7405 10 8		300
FKH GES5	/ St / FS	5437154	7407 86 0		307	GES2 DB 7011	Grey / PA	5102113	7405 10 0		300
FKH GESRM	/ St / FS	5437192	7407 86 4		382	GES2 DB 8014	Sepia brown / PA	5102175	7405 11 2		300
FS R9 10 5	/ HP	5110941	7407 21 2		307	GES2 DB 9011	Graphite black / PA	5102120	7405 10 4		300
FS RA9 10 5	/ HP	5110958	7407 21 6		307	GES2 U 1019	Grey-beige / PA	5102236	7405 12 4		300
GB2	/ PA	5110972	7407 22 4		348	GES2 U 7011	Grey / PA	5102182	7405 11 6		300
GB2 1	/ PA	5111009	7407 22 8		348	GES2 U 8014	Sepia brown / PA	5102243	7405 12 8		300
GB2 BL	/ PA	5111214	7407 28 8		348	GES2 U 9011	Graphite black / PA	5102229	7405 12 0		300
GB2 P01	/ PA	5111245	7407 29 2		348	GES4 DB 1019	Grey-beige / PA	5102465	7405 17 2		300
GB2 P1	/ PA	5111290	7407 30 0		349	GES4 DB 7011	Grey / PA	5102410	7405 16 4		300
GB2 P2	/ PA	5111344	7407 30 8		348	GES4 DB 8014	Sepia brown / PA	5102472	7405 17 6		300
GB2 P3	/ PA	5111351	7407 31 2		349	GES4 DB 9011	Graphite black / PA	5102427	7405 16 8		300
GB23 P01	/ PA	5111016	7407 23 2		253	GES4 U 1019	Grey-beige / PA	5102601	7405 20 4		300
GB23 P01	/ PA	5111016	7407 23 2		348	GES4 U 7011	Grey / PA	5102588	7405 19 6		300
GB23 P01	/ PA	5111016	7407 23 2		350	GES4 U 8014	Sepia brown / PA	5102649	7405 20 8		300
GB23 P02	/ PA	5111030	7407 24 0		253	GES4 U 9011	Graphite black / PA	5102595	7405 20 0		300
GB23 P02	/ PA	5111030	7407 24 0		348	GES4M 10DB	/ V2A	5102533	7405 18 8		301
GB23 P02	/ PA	5111030	7407 24 0		350	GES4M 10U	/ V2A	5102540	7405 19 2		300
GB23 P1	/ PA	5111078	7407 24 8		253	GES6 DB 1019	Grey-beige / PA	5102892	7405 26 8		301
GB23 P1	/ PA	5111078	7407 24 8		349	GES6 DB 7011	Grey / PA	5102847	7405 26 0		301
GB23 P1	/ PA	5111078	7407 24 8		350	GES6 DB 8014	Sepia brown / PA	5102908	7405 27 2		301
GB23 P2	/ PA	5111092	7407 25 6		254	GES6 DB 9011	Graphite black / PA	5102885	7405 26 4		301
GB23 P2	/ PA	5111092	7407 25 6		349	GES6 U 1019	Grey-beige / PA	5103127	7405 31 6		301
GB23 P2	/ PA	5111092	7407 25 6		351	GES6 U 7011	Grey / PA	5103080	7405 30 8		301
GB23 P3	/ PA	5111139	7407 26 4		253	GES6 U 8014	Sepia brown / PA	5103134	7405 32 0		301
GB23 P3	/ PA	5111139	7407 26 4		348	GES6 U 9011	Graphite black / PA	5103110	7405 31 2		301
GB23 P3	/ PA	5111139	7407 26 4		350	GES6M 10DB	/ V2A	5103066	7405 30 0		301
GB23 P4	/ PA	5111146	7407 26 8		253	GES6M 10U	/ V2A	5103073	7405 30 4		301
GB23 P4	/ PA	5111146	7407 26 8		349	GES9 55U V 7011	Grey / PA	5674436	7405 03 7		264
GB23 P4	/ PA	5111146	7407 26 8		350	GES9 55U V 7011	Grey / PA	5674436	7405 03 7		311
GB23 P5	/ PA	5111153	7407 27 2		254	GES9 55U V 9011	Graphite black / PA	5674443	7405 03 9		264
GB23 P5	/ PA	5111153	7407 27 2		349	GES9 55U V 9011	Graphite black / PA	5674443	7405 03 9		311
GB23 P5	/ PA	5111153	7407 27 2		351	GES9-2 U10T 1019	Grey-beige / PA	5681397	7405 05 4		302
GB23 TW	/ PA	5111191	7407 28 0		254	GES9-2 U10T 7011	Grey / PA	5681373	7405 05 0		302
GB23 TW	/ PA	5111191	7407 28 0		351	GES9-2 U10T 9011	Graphite black / PA	5681380	7405 05 2		302
GB3	/ PA	5111412	7407 32 4		253	GES9M 10DB	/ V2A	5103424	7405 38 0		302
GB3	/ PA	5111412	7407 32 4		349	GES9M 10U	/ V2A	5103431	7405 38 4		302
GB3 1	/ PA	5111429	7407 32 8		349	GESR4 U 1019	Grey-beige / PA	5103738	7405 44 4		305
GB3 BL	/ PA	5111450	7407 33 2		350	GESR4 U 7011	Grey / PA	5103684	7405 43 6		305
GB3 P01	/ PA	5111467	7407 33 6		253	GESR4 U 8014	Sepia brown / PA	5103745	7405 44 8		305
GB3 P01	/ PA	5111467	7407 33 6		350	GESR4 U 9011	Graphite black / PA	5103721	7405 44 0		305
GB3 P1	/ PA	5111481	7407 34 4		254	GESR7 10U 1019	Grey-beige / PA	5103806	7405 46 0		305
GB3 P1	/ PA	5111481	7407 34 4		351	GESR7 10U 7011	Grey / PA	5103783	7405 45 2		305
GB3 P2	/ PA	5111528	7407 35 2		254	GESR7 10U 8014	Sepia brown / PA	5103844	7405 46 4		305
GB3 P2	/ PA	5111528	7407 35 2		351	GESR7 10U 9011	Graphite black / PA	5103790	7405 45 6		305
GB3 P3	/ PA	5111542	7407 36 0		253	GESR9 10U 1019	Grey-beige / PA	5103929	7405 48 2		306
GB3 P3	/ PA	5111542	7407 36 0		350	GESR9 10U 7011	Grey / PA	5103905	7405 47 4		306
GBES	/ PA	5111801	7407 42 4		352	GESR9 10U 8014	Sepia brown / PA	5103967	7405 48 6		306
GE 2V VO	95 / V2A / GUF	5626824	7368 38 4		376	GESR9 10U 9011	Graphite black / PA	5103912	7405 47 8		306
						GESR9 55U V 7011	Grey / PA	5674450	7405 04 7		264
						GESR9 55U V 7011	Grey / PA	5674450	7405 04 7		311
						GESR9 55U V 9011	Graphite black / PA	5674467	7405 04 9		264
						GESR9 55U V 9011	Graphite black / PA	5674467	7405 04 9		311

Type listing

Structure of the EAN number: Country code **40**

Manufacturer code **1219** (for articles beginning with **0: 1010**)

Individual EAN-C **5647589**

Type	Dimensions/Colour/Div.	EAN-C.	Art. no.	Price	Page	Type	Dimensions/Colour/Div.	EAN-C.	Art. no.	Price	Page
GESR9 SR U 1019	Grey-beige / PA	5104148	7405 52 0	/pc.	306	GRAFA9 U 9011	Graphite black / AIG	5105367	7405 77 6	/pc.	309
GESR9 SR U 7011	Grey / PA	5104094	7405 51 2		306						
GESR9 SR U 8014	Sepia brown / PA	5104155	7405 52 4		306	GRAFA9M U 7011	Grey / AIG	5105299	7405 76 0		309
GESR9 SR U 9011	Graphite black / PA	5104100	7405 51 6		306	GRAFA9M U 8014	Sepia brown / AIG	5105343	7405 76 8		309
						GRAFA9M U 9011	Graphite black / AIG	5105305	7405 76 4		309
GESR9 U 1019	Grey-beige / PA	5104216	7405 53 6		306						
GESR9 U 7011	Grey / PA	5104162	7405 52 8		306	GT GRAF9	/ V2A	5112419	7407 56 4		309
GESR9 U 8014	Sepia brown / PA	5104223	7405 54 0		306						
GESR9 U 9011	Graphite black / PA	5104209	7405 53 2		306	GT2 CEE16	/ St / FS	5450771	7407 66 3		358
GESRA7 10U	/ AIG	5104261	7405 54 4		306	GT2CEE	/ St / FS	5450788	7407 66 5		358
GESRA7D U 1019	Grey-beige / AIG	5104339	7405 56 0		305	GT3 CEE	/ St / FS	5450832	7407 66 9		358
GESRA7D U 7011	Grey / AIG	5104285	7405 55 2		305						
GESRA7D U 9011	Graphite black / AIG	5104322	7405 55 6		305	GT3 CEE16	/ St / FS	5450825	7407 66 7		358
GESRA7DM U 7011	Grey / AIG	5104384	7405 56 8		305	IBAG 190 4N100	100 / St / FS	5387824	7400 11 9		286
GESRA7DM U 8014	Sepia brown / AIG	5104407	7405 57 6		305	IBAG 190 4N130	130 / St / FS	5088547	7400 12 0		286
GESRA7DM U 9011	Graphite black / AIG	5104391	7405 57 2		305	IBAG 190 4N55	55 / St / FS	5387817	7400 11 8		286
GESRA9 10U	/ AIG	5104445	7405 58 0		306	IBAG 250 4N55	55 / St / FS	5088554	7400 12 4		286
						IBAG 250 6N100	100 / St / FS	5387831	7400 12 6		286
GESRC2 HS	/ Zn / CR	5104452	7405 58 4		379	IBAG 250 6N115	115 / St / FS	5088561	7400 12 8		286
GESRC2 UAB	/ Zn / CR	5104506	7405 59 2		380	IBAG 250 6N130	130 / St / FS	5088608	7400 13 2		286
GESRC2 USB	/ Zn / CR	5104513	7405 59 6		378	IBAG 250 6N40	40 / St / FS	5088615	7400 13 6		286
						IBAG 250 6N55	55 / St / FS	5088622	7400 14 0		286
GESRK2 HS	/ Zn / Cu	5104636	7405 62 0		379	IBAG 250 6N70	70 / St / FS	5088660	7400 14 4		286
						IBAG 250 R4N55	55 / St / FS	5614357	7400 14 7		286
GESRK2 UAB	/ Zn / Cu	5104681	7405 62 8		380	IBAZ 190 100	100 / St / FS	5088677	7400 14 8		286
GESRK2 USB	/ Zn / Cu	5104698	7405 63 2		378	IBAZ 190 115	115 / St / FS	5088684	7400 15 2		286
						IBAZ 190 55	55 / St / FS	5088714	7400 15 6		286
GESRMS2 HS	/ Zn / CuZn	5104759	7405 64 4		379	IBAZ 190 85	85 / St / FS	5088721	7400 16 0		286
GESRMS2 UAB	/ Zn / CuZn	5104810	7405 65 6		380						
GESRMS2 USB	/ Zn / CuZn	5104827	7405 66 0		378	IBAZ 250 100	100 / St / FS	5088738	7400 16 4		286
						IBAZ 250 115	115 / St / FS	5365563	7400 16 5		286
GESRN 2HS	/ Zn / N	5104926	7405 67 6		379	IBAZ 250 130	130 / St / FS	5088745	7400 16 8		286
GESRN2 UAB	/ Zn / N	5104988	7405 68 8		379	IBAZ 250 145	145 / St / FS	5088783	7400 17 2		286
GESRN2 USB	/ Zn / N	5105053	7405 70 8		378	IBAZ 250 170	170 / St / FS	5691051	7400 17 5		286
						IBAZ 250 40	40 / St / FS	5088790	7400 17 6		286
GESRSM2 HS	/ Zn / CR	5385738	7405 72 2		379	IBAZ 250 55	55 / St / FS	5088806	7400 18 0		286
GESRSM2 UAB	/ Zn / CR	5416029	7405 72 3		380	IBAZ 250 70	70 / St / FS	5088844	7400 18 4		286
GESRSM2 USB	/ Zn / CR	5385721	7405 72 1		378	IBAZ 250 85	85 / St / FS	5365570	7400 18 6		286
GH N 20	/ V2A	5426295	7406 86 5		335	IBD 25038	45 / St / FS	5088295	7400 06 0		284
GH N 25	/ V2A	5426301	7406 86 6		335	IBD 25048	55 / St / FS	5088301	7400 06 4		285
GH NR SL20	/ V2A	5426332	7406 87 0		335	IBD 35038	45 / St / FS	5088318	7400 06 8		284
GH NR SL25	/ V2A	5426349	7406 87 1		335	IBDS 25038 165	165 45 / St / FS	5088325	7400 07 2		284
GH RK 10	/ V2A	5426080	7406 85 0		335	IBDS 25048 145	145 55 / St / FS	5088356	7400 07 6		285
GH RK 15	/ V2A	5426097	7406 85 1		335	IBDS 35038 115	115 45 / St / FS	5088363	7400 08 0		284
GH RK 20	/ V2A	5426103	7406 85 2		335	IBDS 35038 165	165 45 / St / FS	5088370	7400 08 4		284
GH RK 25	/ V2A	5426110	7406 85 3		335	IBDS 35038 80	80 45 / St / FS	5088387	7400 08 8		284
GH RK 30	/ V2A	5426127	7406 85 4		335	IBDS 35048 105	105 55 / St / FS	5088417	7400 09 2		285
GH RK 40	/ V2A	5614005	7406 85 6		335	IBDS 35048 115	115 55 / St / FS	5088424	7400 09 6		285
						IBDS 35048 125	125 55 / St / FS	5088431	7400 10 0		285
						IBDS 35048 135	135 55 / St / FS	5088448	7400 10 4		285
						IBDS 35048 145	145 55 / St / FS	5088486	7400 10 8		285
						IBDS 35048 165	165 55 / St / FS	5088493	7400 11 2		285
						IBDS 35048 175	175 55 / St / FS	5088509	7400 11 6		285
GH RK SL20	/ V2A	5426158	7406 85 9		335	IBK KL 19038	151 115 / St / FS	5313717	7400 25 0		280
GH RK SL25	/ V2A	5426165	7406 86 0		335	IBK KL 19048	151 115 / St / FS	5313724	7400 25 1		282
GH RK SL30	/ V2A	5426172	7406 86 1		335	IBK KL 25038	191 155 / St / FS	5313731	7400 25 2		280
GH RK SL40	/ V2A	5426189	7406 86 2		335	IBK KL 25048	191 155 / St / FS	5313748	7400 25 3		282
GRAF9 U 1019	Grey-beige / AIG	5105244	7405 75 2		309	IBK KL 35038	251 215 / St / FS	5313779	7400 25 4		280
GRAF9 U 7011	Grey / AIG	5105220	7405 74 4		309	IBK KL 35048	251 215 / St / FS	5313786	7400 25 5		282
GRAF9 U 8014	Sepia brown / AIG	5105282	7405 75 6		309						
GRAF9 U 9011	Graphite black / AIG	5105237	7405 74 8		309						
GRAF9M U 7011	Grey / AIG	5105169	7405 73 2		309	IBK2 19038	77 107 / St / FS	5088134	7400 00 8	/m	280
GRAF9M U 8014	Sepia brown / AIG	5105183	7405 74 0		309	IBK2 25038	107 137 / St / FS	5088141	7400 01 2		280
GRAF9M U 9011	Graphite black / AIG	5105176	7405 73 6		309	IBK2 25048	107 137 / St / FS	5088189	7400 01 6		282
GRAFA9 U 1019	Grey-beige / AIG	5105404	7405 78 0		309						
GRAFA9 U 7011	Grey / AIG	5105350	7405 77 2		309	IBK2 35038	157 187 / St / FS	5088202	7400 02 4		280
GRAFA9 U 8014	Sepia brown / AIG	5105411	7405 78 4		309						

08 UFS_Katalog_2010_Neuer_Stand / en / 25/02/2010 (LLEExport_00997)

Type	Dimensions/Colour/Div.	EAN-C.	Art. no.	Price	Page	Type	Dimensions/Colour/Div.	EAN-C.	Art. no.	Price	Page
IBK2 35048	157 187/ St / FS	5088196	7400 02 0	/m	282	KV2 25028	110 140/ St / FS	5090359	7400 63 2	/pc.	206
						KV2 25028	110 140/ St / FS	5090359	7400 63 2		270
IBK3 35038	117 109/ St / FS	5088233	7400 02 8		280						
IBK3 35048	117 109/ St / FS	5088240	7400 03 2		282	KV2 25038	110 140/ St / FS	5090366	7400 63 6		208
						KV2 25038	110 140/ St / FS	5090366	7400 63 6		272
IBK3-1 19038	57 69/ St / FS	5088257	7400 03 6		280	KV2 25038	110 140/ St / FS	5090366	7400 63 6		281
IBK3-1 19048	57 69/ St / FS	5088264	7400 04 0		282						
						KV2 25048	110 140/ St / FS	5090397	7400 64 0		210
						KV2 25048	110 140/ St / FS	5090397	7400 64 0		274
IBST 108	108/ St / FS	5088851	7400 20 0	/pc.	280	KV2 25048	110 140/ St / FS	5090397	7400 64 0		282
IBST 108	108/ St / FS	5088851	7400 20 0		282						
						KV3 25028	90 70/ St / FS	5090403	7400 64 4		207
IBST 118	118/ St / FS	5088868	7400 20 4		280						
IBST 118	118/ St / FS	5088868	7400 20 4		282	KV3 25038	90 70/ St / FS	5090410	7400 64 8		209
						KV3 25038	90 70/ St / FS	5090410	7400 64 8		281
IBST 128	128/ St / FS	5088905	7400 20 8		280						
IBST 128	128/ St / FS	5088905	7400 20 8		282	KV3 25048	90 70/ St / FS	5090427	7400 65 2		211
						KV3 25048	90 70/ St / FS	5090427	7400 65 2		283
IBST 138	138/ St / FS	5088912	7400 21 2		280						
IBST 138	138/ St / FS	5088912	7400 21 2		282	KV3 35028	120 110/ St / FS	5090458	7400 65 6		207
IBST 158	158/ St / FS	5088929	7400 21 6		280	KV3 35038	120 110/ St / FS	5090465	7400 66 0		209
IBST 158	158/ St / FS	5088929	7400 21 6		282	KV3 35038	120 110/ St / FS	5090465	7400 66 0		281
IBST 168	168/ St / FS	5088967	7400 22 0		280	KV3 35048	120 110/ St / FS	5090472	7400 66 4		211
IBST 168	168/ St / FS	5088967	7400 22 0		282	KV3 35048	120 110/ St / FS	5090472	7400 66 4		283
IBST 188	188/ St / FS	5088974	7400 22 4		280	KV3-3 25028	250 250/ St / FS	5090489	7400 66 8		270
IBST 188	188/ St / FS	5088974	7400 22 4		282	KV3-3 25038	250 250/ St / FS	5090519	7400 67 2		272
						KV3-3 25048	250 250/ St / FS	5090526	7400 67 6		274
IBST 218	218/ St / FS	5691068	7400 22 7		280						
IBST 218	218/ St / FS	5691068	7400 22 7		282	LP 45	/ PA	5112440	7407 58 4		352
IBST 228	228/ St / FS	5088981	7400 22 8		280	LP R	/ PA	5112433	7407 58 0		352
IBST 228	228/ St / FS	5088981	7400 22 8		282						
						LPA GB2	165/ PVC / FS	5112457	7407 58 8		357
IBST 48	48/ St / FS	5089025	7400 23 2		280						
IBST 48	48/ St / FS	5089025	7400 23 2		282	LPA GB3	208/ PVC / FS	5112464	7407 59 2		357
IBST 58	58/ St / FS	5089032	7400 23 6		280						
IBST 58	58/ St / FS	5089032	7400 23 6		282					/100 pc.	
						MMS6X50	6 x 50 50/ ST / GC	5963929	3498 10 7		212
IBST 68	68/ St / FS	5089049	7400 24 0		280						
IBST 68	68/ St / FS	5089049	7400 24 0		282						
IBST 78	78/ St / FS	5089087	7400 24 4		280	MPMT45 2A	/ V2A	5693468	7408 70 1	/pc.	265
IBST 78	78/ St / FS	5089087	7400 24 4		282	MPMT45 2A	/ V2A	5693468	7408 70 1		312
						MPMT45 2B	/ V2A	5693475	7408 70 3		265
IBST 88	88/ St / FS	5089094	7400 24 8		280	MPMT45 2B	/ V2A	5693475	7408 70 3		312
IBST 88	88/ St / FS	5089094	7400 24 8		282	MPMT45 2C	/ V2A	5693482	7408 70 5		265
						MPMT45 2C	/ V2A	5693482	7408 70 5		312
IBST 98	98/ St / FS	5627395	7400 24 9		280	MPMT45 2F	/ V2A	5693499	7408 70 7		265
IBST 98	98/ St / FS	5627395	7400 24 9		282	MPMT45 2F	/ V2A	5693499	7408 70 7		312
						MPMT45 2LE	/ V2A	5693505	7408 70 9		265
IBVL 19038	194 38/ St / FS	5089148	7400 26 4		280	MPMT45 2LE	/ V2A	5693505	7408 70 9		312
IBVL 19048	/ St / FS	5089155	7400 26 8		282						
						MPR2 1LE	/ V2A	5695646	7407 62 8		381
IBVL 25038	254 38/ St / FS	5089162	7400 27 2		280						
IBVL 25048	/ St / FS	5089209	7400 27 6		282	MPR2 2A	/ V2A	5372486	7407 62 0		381
IBVL 35038	354 38/ St / FS	5089216	7400 28 0		280	MPR2 2B	/ V2A	5372523	7407 62 2		381
IBVL 35048	/ St / FS	5089223	7400 28 4		282						
						MPR2 2C	/ V2A	5372530	7407 62 4		381
KFB R9	/ PA	5112426	7407 56 8		307	MPR2 2F	/ V2A	5372547	7407 62 6		381
KS-S		5448259	7205 42 5		406	MPR2XD	/ St / FS	5112594	7407 63 4		381
KS-S		5448259	7205 42 5		407						
						MS REG1	/ St / FS	5112679	7407 65 8		357
KV2 19028	80 110/ St / FS	5090304	7400 62 0		206	MS REG2	/ St / FS	5112686	7407 66 2		357
KV2 19028	80 110/ St / FS	5090304	7400 62 0		270						
						MS250-2 3GB3	/ St / FS	5112617	7407 64 2		320
KV2 19038	80 110/ St / FS	5090335	7400 62 4		208						
KV2 19038	80 110/ St / FS	5090335	7400 62 4		272	MS3 GB2	/ St / FS	5112655	7407 65 0		341
KV2 19038	80 110/ St / FS	5090335	7400 62 4		281						
						MS3 GB3	/ St / FS	5112662	7407 65 4		341
KV2 19048	80 110/ St / FS	5090342	7400 62 8		210						
KV2 19048	80 110/ St / FS	5090342	7400 62 8		274	MS350-2 3GB3	/ St / FS	5112624	7407 64 6		320
KV2 19048	80 110/ St / FS	5090342	7400 62 8		282						
						MT2 2ACO	/ V2A	5112730	7407 68 8		357

Type listing

Structure of the EAN number: Country code **40**

Manufacturer code **1219** (for articles beginning with **0: 1010**)

Individual EAN-C **5647589**

Type	Dimensions/Colour/Div.	EAN-C.	Art. no.	Price	Page	Type	Dimensions/Colour/Div.	EAN-C.	Art. no.	Price	Page
MT3 3ACO	/ V2A	5112839	7407 71 2	/pc.	357	MTM 3C	/ V2A / FS	5113263	7407 82 8	/pc.	355
MT3 45	/ PA	5303664	7429 15 0		352	MTM 3E	/ V2A / FS	5113270	7407 83 2		355
MT3 45	/ PA	5303664	7429 15 0		386	MTM 3F	/ V2A / FS	5417965	7407 83 3		355
MT3 45 2-1	/ PA	5417064	7429 13 1		353	MTU 2	/ St / FS	5113287	7407 83 6		354
MT4 45	/ PA	5303701	7429 15 4		352	MTU 3	/ St / FS	5113294	7407 84 0		354
MT4 45	/ PA	5303701	7429 15 4		386	MTU ZE	/ St / FS	5113300	7407 84 4		354
MT4 45 2-2	/ PA	5417101	7429 13 9		254	NE DSU2 10075	100-175 / St / FS	5245131	7424 84 4		232
MT4 45 2-2	/ PA	5417101	7429 13 9		353	NE DSU2 10075	100-175 / St / FS	5245131	7424 84 4		259
MT4 45 3-1	/ PA	5417095	7429 13 5		254	NE DSU2 17075	170-245 / St / FS	5245148	7424 84 6		232
MT4 45 3-1	/ PA	5417095	7429 13 5		353	NE DSU2 17075	170-245 / St / FS	5245148	7424 84 6		260
MT4 45 OKB	/ PA	5699729	7403 87 0		250	NE DSU2 4030	40-70 / St / FS	5245117	7424 84 0		232
MT45V 2+2	/ PA	5674528	7408 68 2		264	NE DSU2 4030	40-70 / St / FS	5245117	7424 84 0		259
MT45V 2+2	/ PA	5674528	7408 68 2		311	NE DSU2 6050	60-110 / St / FS	5245124	7424 84 2		232
MT45V 2+2	/ PA	5674528	7408 68 2		311	NE DSU2 6050	60-110 / St / FS	5245124	7424 84 2		259
MT45V 3	/ PA	5674504	7408 67 2		264	NW 250-3 QK	/ St / FS	5432753	7410 54 0		329
MT45V 3	/ PA	5674504	7408 67 2		311	NW 250-3 RK	/ St / FS	5432777	7410 55 2		333
MT45V 3+1	/ PA	5674511	7408 68 0		264	NW 350-3 QK	/ St / FS	5432760	7410 54 4		329
MT45V 3+1	/ PA	5674511	7408 68 0		311	NW 350-3 RK	/ St / FS	5432784	7410 55 6		333
MT45V 4	/ PA	5674498	7408 67 0		264	OKA BA4 3	2400 4/ Al	5099338	7404 22 0	/m	242
MT45V 4	/ PA	5674498	7408 67 0		311	OKA D 300	300 800/ St / FS	5093954	7401 99 7	/pc.	243
MT45V TW	/ PA	5674566	7408 69 3		265	OKA D 300 R	300 800/ St / FS	5254744	7425 02 2		243
MT45V TW	/ PA	5674566	7408 69 3		312	OKA D 400 R	400 800/ St / FS	5254751	7425 02 4		243
MTGE2 1K	/ V2A	5626893	7407 85 0		376	OKA D 500	500 800/ St / FS	5245353	7425 00 6		243
MTGE2 2A	/ V2A	5626855	7407 84 6		376	OKA D 500 4	500 400/ St / FS	5245421	7425 06 4		244
MTGE2 2B	/ V2A	5626862	7407 84 7		376	OKA D 500 6	500 400/ St / FS	5245445	7425 08 4		244
MTGE2 2C	/ V2A	5626879	7407 84 8		376	OKA D 500 9	500 400/ St / FS	5245469	7425 10 2		244
MTGE2 2F	/ V2A	5626886	7407 84 9		376	OKA D 500 DAT	500 400/ St / FS	5245407	7425 04 6		243
MTGE2 2LE	/ V2A	5623472	7407 67 9		376	OKA D 500 R	500 800/ St / FS	5245384	7425 02 6		243
MTM 0	/ St / FS	5113027	7407 76 4		356	OKA D 500 R9	500 400/ St / FS	5245483	7425 12 2		245
MTM 1D	/ V2A / FS	5113034	7407 76 8		355	OKA D 600	600 800/ St / FS	5245360	7425 00 8		243
MTM 1K	/ V2A / FS	5113072	7407 77 6		355	OKA D 600 4	600 400/ St / FS	5245438	7425 06 6		244
MTM 2A	/ V2A / FS	5113089	7407 78 0		354	OKA D 600 6	600 400/ St / FS	5245452	7425 08 6		244
MTM 2B	/ V2A / FS	5113096	7407 78 4		354	OKA D 600 9	600 400/ St / FS	5245476	7425 10 4		244
MTM 2C	/ V2A / FS	5113102	7407 78 8		354	OKA D 600 DAT	600 400/ St / FS	5245414	7425 04 8		243
MTM 2D	/ V2A / FS	5415978	7407 79 0		355	OKA D 600 R	600 800/ St / FS	5245391	7425 02 8		243
MTM 2F	/ V2A / FS	5113133	7407 79 2		355	OKA D 600 R9	600 400/ St / FS	5245490	7425 12 4		245
MTM 2G	/ V2A / FS	5113140	7407 79 6		355	OKA DG4 300	300 800/ St / FS	5094067	7402 04 0		244
MTM 2H	/ V2A / FS	5113157	7407 80 0		355	OKA DG4 400	400 800/ St / FS	5094081	7402 04 8		244
MTM 2K	/ V2A / FS	5113164	7407 80 4		356	OKA DG6 400	400 800/ St / FS	5094128	7402 05 6		244
MTM 2L	/ V2A / FS	5113195	7407 80 8		356	OKA DG9 400	400 800/ St / FS	5094142	7402 06 4		244
MTM 2LE	/ V2A	5623489	7407 79 8		356	OKA DGR9 400	400 800/ St / FS	5094173	7402 06 8		244
MTM 2M	/ V2A / FS	5113201	7407 81 2		356	OKA FB2 TX	/ Zn	5651574	7424 82 1		241
MTM 2N	/ V2A / FS	5113218	7407 81 6		356	OKA FD	15000 6/ MGUM	5245100	7424 82 2	/m	242
MTM 2P	/ St / FS	5455806	7407 81 7		356	OKA NEVE 110	110 40-110 / St	5434757	7425 97 0	/pc.	242
MTM 2Q	/ V2A	5688624	7407 81 8		356	OKA NEVE 150	150 40-150 / St	5434764	7425 97 2		242
MTM 3A	/ V2A / FS	5113225	7407 82 0		354	OKA NEVE 250	250 40-250 / St	5434795	7425 97 4		242
MTM 3B	/ V2A / FS	5113256	7407 82 4		354	OKA RK 200 15	200/ V2A / FS	5245513	7425 30 0		243
						OKA RK 300 15	300/ V2A / FS	5245520	7425 31 0		243
						OKA RK 400 15	400/ V2A / FS	5245537	7425 32 0		243
						OKA RK 500 15	500/ V2A	5245544	7425 33 0		243
						OKA RK 600 15	600/ V2A	5245551	7425 34 0		243

08_UFS_Katalog_2010_Neuer_Stand_en / 25/02/2010 (LLEExport_00997)

Type	Dimensions/Colour/Div.	EAN-C.	Art. no.	Price	Page	Type	Dimensions/Colour/Div.	EAN-C.	Art. no.	Price	Page
OKA2 D 200	200 800/ St / FS	5093510	7401 87 0	/pc.	243	OKA-G40040140	400 2400/ St / FS	5242949	7424 00 4	/m	258
OKA2 D 400	400 800/ St / FS	5093602	7401 89 8		243	OKA-G40040140	400 2400/ St / FS	5242949	7424 00 4		226
OKA2 DAT 200	200 800/ St / FS	5093640	7401 90 4		243	OKA-G40040140D4	400 2400/ St / FS	5243465	7424 12 2		227
OKA2 DAT 300	300 800/ St / FS	5093664	7401 91 2		243	OKA-G40040140D6	400 2400/ St / FS	5243571	7424 16 2		228
OKA2 DAT 400	400 800/ St / FS	5093701	7401 92 0		243	OKA-G40040140D9	400 2400/ St / FS	5243656	7424 20 0		228
					243	OKA-G40040140DAT	400 2400/ St / FS	5243335	7424 08 4		227
					243	OKA-G40040140DR9	400 2400/ St / FS	5243717	7424 24 0		229
					243	OKA-G40040140R	400 2400/ St / FS	5243168	7424 04 4		226
OKA2 TW 100	2400 86,5/ St / FS	5093817	7401 96 0	/m	240	OKA-G40040150ES	400 40-140 / St / FS	5243830	7424 28 4	/pc.	241
OKA2 TW 110	2400 96,5/ St / FS	5093824	7401 96 4		240	OKA-G40040150ES	400 40-140 / St / FS	5243830	7424 28 4		260
OKA2 TW 120	2400 106,5/ St / FS	5093831	7401 96 8		240	OKA-G40040150ES	400 40-140 / St / FS	5243830	7424 28 4		262
OKA2 TW 130	2400 116,5/ St / FS	5093848	7401 97 2		240	OKA-G40040150FBL	400 40-140 / St / FS	5651314	7423 95 4		242
OKA2 TW 140	2400 126,5/ St / FS	5093879	7401 97 6		240	OKA-G40040150FBR	400 40-140 / St / FS	5651451	7423 97 4		241
OKA2 TW 150	2400 136,5/ St / FS	5093886	7401 98 0		240						
OKA2 TW 30	2400 16,5/ St / FS	5093893	7401 98 4		240	OKA-G40040240	400 2400/ St / FS	5243052	7424 02 4	/m	226
OKA2 TW 40	2400 26,5/ St / FS	5093909	7401 98 8		240	OKA-G40040240D4	400 2400/ St / FS	5243526	7424 14 2		227
OKA2 TW 50	2400 36,5/ St / FS	5093930	7401 99 2		240	OKA-G40040240D6	400 2400/ St / FS	5243601	7424 18 2		228
OKA2 TW 60	2400 46,5/ St / FS	5093947	7401 99 6		240	OKA-G40040240D9	400 2400/ St / FS	5243687	7424 22 0		228
OKA2 TW 70	2400 56,5/ St / FS	5093992	7402 00 0		240	OKA-G40040240DAT	400 2400/ St / FS	5243403	7424 10 4		227
OKA2 TW 80	2400 66,5/ St / FS	5094005	7402 00 4		240	OKA-G40040240DR9	400 2400/ St / FS	5243762	7424 26 0		229
OKA2 TW 90	2400 76,5/ St / FS	5094012	7402 00 8		240						
OKAD 200 R	200 800/ St / FS	5245377	7425 02 0	/pc.	243	OKA-G40040240ES	400 40-240 / St / FS	5243908	7424 30 4	/pc.	241
					243	OKA-G40040240FBL	400 40-240 / St / FS	5651369	7423 96 4		242
					243	OKA-G40040240FBR	400 40-240 / St / FS	5651529	7423 98 4		241
OKA-G A 40140 4	400 201/ St / FS	5243953	7424 32 0		230	OKA-G40040240R	400 2400/ St / FS	5243243	7424 06 4	/m	226
OKA-G A 40140 6	400 201/ St / FS	5243960	7424 32 2		230						
OKA-G A 40140 9	400 244/ St / FS	5243991	7424 32 4		230	OKA-G50040140	500 2400/ St / FS	5242987	7424 00 6		258
OKA-G A 40140 9	400 244/ St / FS	5243991	7424 32 4		231	OKA-G50040140	500 2400/ St / FS	5242987	7424 00 6		226
OKA-G A 40140R9	400 305/ St / FS	5244004	7424 32 6		259	OKA-G50040140D4	500 2400/ St / FS	5243472	7424 12 4		227
OKA-G A 40140R9	400 305/ St / FS	5244004	7424 32 6		259	OKA-G50040140D6	500 2400/ St / FS	5243588	7424 16 4		228
OKA-G A 40240 4	400 201/ St / FS	5244011	7424 34 0		230	OKA-G50040140D9	500 2400/ St / FS	5243663	7424 20 2		228
OKA-G A 40240 6	400 201/ St / FS	5244028	7424 34 2		230	OKA-G50040140DAT	500 2400/ St / FS	5243342	7424 08 6		227
OKA-G A 40240 9	400 244/ St / FS	5244059	7424 34 4		231	OKA-G50040140DR9	500 2400/ St / FS	5243724	7424 24 2		229
OKA-G A 40240R9	400 305/ St / FS	5244066	7424 34 6		231	OKA-G50040140R	500 2400/ St / FS	5243175	7424 04 6		226
OKA-G20040140	200 2400/ St / FS	5242925	7424 00 0	/m	226	OKA-G50040150ES	500 40-140 / St / FS	5243847	7424 28 6	/pc.	241
OKA-G20040140	200 2400/ St / FS	5242925	7424 00 0		258	OKA-G50040150ES	500 40-140 / St / FS	5243847	7424 28 6		260
OKA-G20040140DAT	200 2400/ St / FS	5243298	7424 08 0		227	OKA-G50040150ES	500 40-140 / St / FS	5243847	7424 28 6		262
OKA-G20040140R	200 2400/ St / FS	5243113	7424 04 0		226	OKA-G50040150FBL	500 40-140 / St / FS	5651321	7423 95 6		242
OKA-G20040150ES	200 40-140 / St / FS	5243816	7424 28 0	/pc.	241	OKA-G50040150FBR	500 40-140 / St / FS	5651468	7423 97 6	/m	241
OKA-G20040150ES	200 40-140 / St / FS	5243816	7424 28 0		260	OKA-G50040240	500 2400/ St / FS	5243069	7424 02 6		226
OKA-G20040150ES	200 40-140 / St / FS	5243816	7424 28 0		262	OKA-G50040240D4	500 2400/ St / FS	5243533	7424 14 4		227
OKA-G20040150FBL	200 40-140 / St / FS	5651291	7423 95 0		242	OKA-G50040240D6	500 2400/ St / FS	5243632	7424 18 4		228
OKA-G20040150FBR	200 40-140 / St / FS	5651420	7423 97 0		241	OKA-G50040240D9	500 2400/ St / FS	5243694	7424 22 2		228
OKA-G20040240	200 2400/ St / FS	5243007	7424 02 0	/m	226	OKA-G50040240DAT	500 2400/ St / FS	5243410	7424 10 6		227
OKA-G20040240DAT	200 2400/ St / FS	5243366	7424 10 0		227	OKA-G50040240DR9	500 2400/ St / FS	5243779	7424 26 2		229
OKA-G20040240ES	200 40-240 / St / FS	5243885	7424 30 0	/pc.	241	OKA-G50040240ES	500 40-240 / St / FS	5243939	7424 30 6	/pc.	241
OKA-G20040240FBL	200 40-240 / St / FS	5651345	7423 96 0		242	OKA-G50040240FBL	500 40-240 / St / FS	5651406	7423 96 6		242
OKA-G20040240FBR	200 40-240 / St / FS	5651482	7423 98 0		241	OKA-G50040240FBR	500 40-240 / St / FS	5651536	7423 98 6		241
OKA-G20040240R	200 2400/ St / FS	5243229	7424 06 0	/m	226	OKA-G50040240R	500 2400/ St / FS	5243274	7424 06 6		226
OKA-G30040140	300 2400/ St / FS	5242932	7424 00 2		258	OKA-G60040140	600 2400/ St / FS	5242994	7424 00 8		258
OKA-G30040140	300 2400/ St / FS	5242932	7424 00 2		226	OKA-G60040140	600 2400/ St / FS	5242994	7424 00 8		226
OKA-G30040140D4	300 2400/ St / FS	5243458	7424 12 0		227	OKA-G60040140D4	600 2400/ St / FS	5243489	7424 12 6		227
OKA-G30040140DAT	300 2400/ St / FS	5243304	7424 08 2		226	OKA-G60040140D6	600 2400/ St / FS	5243595	7424 16 6		228
OKA-G30040140R	300 2400/ St / FS	5243120	7424 04 2		227	OKA-G60040140D9	600 2400/ St / FS	5243670	7424 20 4		228
OKA-G30040150ES	300 40-140 / St / FS	5243823	7424 28 2	/pc.	241	OKA-G60040140DR9	600 2400/ St / FS	5243359	7424 08 8		227
OKA-G30040150ES	300 40-140 / St / FS	5243823	7424 28 2		260	OKA-G60040140R	600 2400/ St / FS	5243755	7424 24 6		229
OKA-G30040150ES	300 40-140 / St / FS	5243823	7424 28 2		262	OKA-G60040140R	600 2400/ St / FS	5243182	7424 04 8		226
OKA-G30040150FBL	300 40-140 / St / FS	5651307	7423 95 2		241	OKA-G60040150ES	600 40-140 / St / FS	5243878	7424 28 8	/pc.	241
OKA-G30040150FBR	300 40-140 / St / FS	5651581	7423 97 2		241	OKA-G60040150ES	600 40-140 / St / FS	5243878	7424 28 8		260
OKA-G30040240	300 2400/ St / FS	5243045	7424 02 2	/m	226	OKA-G60040150ES	600 40-140 / St / FS	5243878	7424 28 8		262
OKA-G30040240D4	300 2400/ St / FS	5243519	7424 14 0		227	OKA-G60040150FBL	600 40-140 / St / FS	5651338	7423 95 8		242
OKA-G30040240DAT	300 2400/ St / FS	5243397	7424 10 2		227	OKA-G60040150FBR	600 40-140 / St / FS	5651475	7423 97 8		241
OKA-G30040240ES	300 40-240 / St / FS	5243892	7424 30 2	/pc.	241	OKA-G60040240	600 2400/ St / FS	5243106	7424 02 8	/m	226
OKA-G30040240FBL	300 40-240 / St / FS	5651352	7423 96 2		242	OKA-G60040240D4	600 2400/ St / FS	5243540	7424 14 6		227
OKA-G30040240FBR	300 40-240 / St / FS	5651512	7423 98 2		241	OKA-G60040240D6	600 2400/ St / FS	5243649	7424 18 6		228
OKA-G30040240R	300 2400/ St / FS	5243236	7424 06 2	/m	226	OKA-G60040240D9	600 2400/ St / FS	5243700	7424 22 4		228
					241	OKA-G60040240DAT	600 2400/ St / FS	5243427	7424 10 8		227
					241	OKA-G60040240DR9	600 2400/ St / FS	5243786	7424 26 4		229
					241	OKA-G60040240ES	600 40-240 / St / FS	5243946	7424 30 8	/pc.	241

08 UFS_Katalog_2010_Neuer_Stand / en / 25/02/2010 (LLEExport_00997)

Type listing

Structure of the EAN number: Country code **40**

Manufacturer code **1219** (for articles beginning with **0: 1010**)

Individual EAN-C **5647589**

Type	Dimensions/Colour/Div.	EAN-C.	Art. no.	Price	Page	Type	Dimensions/Colour/Div.	EAN-C.	Art. no.	Price	Page
				/pc.						/m	
OKA-G60040240FBL	600 40-240 / St / FS	5651413	7423 96 8		242	OKA-W5006050	500 2400 / St / FS	5244240	7424 42 6		233
OKA-G60040240FBR	600 40-240 / St / FS	5651543	7423 98 8		241	OKA-W5006050D4	500 2400 / St / FS	5244691	7424 60 4		235
				/m		OKA-W5006050D6	500 2400 / St / FS	5244769	7424 66 4		235
OKA-G60040240R	600 2400 / St / FS	5243281	7424 06 8		226	OKA-W5006050D9	500 2400 / St / FS	5244899	7424 72 2		236
				/pc.		OKA-W5006050D9	500 2400 / St / FS	5244899	7424 72 2		236
OKA-W A 10050 4	400 201 / St / FS	5245216	7424 92 0		238	OKA-W5006050DAT	500 2400 / St / FS	5244608	7424 54 6		234
OKA-W A 10050 6	400 201 / St / FS	5245223	7424 92 2		238	OKA-W5006050DR9	500 2400 / St / FS	5245025	7424 78 2		237
OKA-W A 10050 9	400 244 / St / FS	5245230	7424 92 4		239	OKA-W5006050R	500 2400 / St / FS	5244455	7424 48 6		234
OKA-W A 10050R9	400 305 / St / FS	5245247	7424 92 6		239	OKA-W60010050	600 2400 / St / FS	5244325	7424 45 8		233
OKA-W A 4030 9	400 244 / St / FS	5245155	7424 88 4		238	OKA-W60010050D4	600 2400 / St / FS	5244745	7424 62 6		235
OKA-W A 4030 9	400 244 / St / FS	5245155	7424 88 4		262	OKA-W60010050D6	600 2400 / St / FS	5244806	7424 68 6		236
OKA-W A 4030R9	400 305 / St / FS	5245162	7424 88 6		239	OKA-W60010050D9	600 2400 / St / FS	5244950	7424 74 4		236
OKA-W A 4030R9	400 305 / St / FS	5245162	7424 88 6		262	OKA-W60010050DAT	600 2400 / St / FS	5244660	7424 56 8		235
OKA-W A 6050 4	400 201 / St / FS	5245179	7424 90 0		238	OKA-W60010050DR9	600 2400 / St / FS	5245087	7424 80 4		237
OKA-W A 6050 6	400 201 / St / FS	5245186	7424 90 2		238	OKA-W60010050R	600 2400 / St / FS	5244516	7424 50 8		234
OKA-W A 6050 9	400 244 / St / FS	5245193	7424 90 4		238	OKA-W6004030	600 2400 / St / FS	5244189	7424 40 8		261
OKA-W A 6050R9	400 305 / St / FS	5245209	7424 90 6		239	OKA-W6004030	600 2400 / St / FS	5244189	7424 40 8		233
				/m		OKA-W6004030D9	600 2400 / St / FS	5244851	7424 70 4		236
OKA-W20010050	200 2400 / St / FS	5244264	7424 44 0		233	OKA-W6004030DAT	600 2400 / St / FS	5244561	7424 52 8		234
OKA-W20010050DAT	200 2400 / St / FS	5244622	7424 56 0		235	OKA-W6004030DR9	600 2400 / St / FS	5244981	7424 76 4		237
OKA-W20010050R	200 2400 / St / FS	5244479	7424 50 0		234	OKA-W6004030R	600 2400 / St / FS	5244417	7424 46 8		233
OKA-W2004030	200 2400 / St / FS	5244127	7424 40 0		233	OKA-W6006050	600 2400 / St / FS	5244257	7424 42 8		233
OKA-W2004030	200 2400 / St / FS	5244127	7424 40 0		261	OKA-W6006050D4	600 2400 / St / FS	5244707	7424 60 6		235
OKA-W2004030DAT	200 2400 / St / FS	5244523	7424 52 0		234	OKA-W6006050D6	600 2400 / St / FS	5244776	7424 66 6		235
OKA-W2004030R	200 2400 / St / FS	5244356	7424 46 0		233	OKA-W6006050D9	600 2400 / St / FS	5244905	7424 72 4		236
OKA-W2006050	200 2400 / St / FS	5244196	7424 42 0		233	OKA-W6006050DR9	600 2400 / St / FS	5244905	7424 72 4		236
OKA-W2006050DAT	200 2400 / St / FS	5244578	7424 54 0		234	OKA-W6006050DAT	600 2400 / St / FS	5244615	7424 54 8		234
OKA-W2006050R	200 2400 / St / FS	5244424	7424 48 0		234	OKA-W6006050DR9	600 2400 / St / FS	5245032	7424 78 4		237
						OKA-W6006050R	600 2400 / St / FS	5244462	7424 48 8		234
OKA-W30010050	300 2400 / St / FS	5244295	7424 44 2		233					/pc.	
OKA-W30010050D4	300 2400 / St / FS	5244714	7424 62 0		235	OKB AE 25085	250 93 / St / FS	5699583	7403 83 0		248
OKA-W30010050DAT	300 2400 / St / FS	5244639	7424 56 2		235						
OKA-W30010050R	300 2400 / St / FS	5244486	7424 50 2		234	OKB DSD 250	/ St / FS	5699637	7403 84 5		249
OKA-W3004030	300 2400 / St / FS	5244134	7424 40 2		261					/m	
OKA-W3004030	300 2400 / St / FS	5244134	7424 40 2		233						
OKA-W3004030DAT	300 2400 / St / FS	5244530	7424 52 2		234	OKB E 21085	210 93 / St / FS	5699545	7403 81 0		248
OKA-W3004030R	300 2400 / St / FS	5244363	7424 46 2		233					/pc.	
OKA-W3006050	300 2400 / St / FS	5244202	7424 42 2		233						
OKA-W3006050D4	300 2400 / St / FS	5244677	7424 60 0		235	OKB ES 25085	250 85-125 / St / FS	5699569	7403 82 0		248
OKA-W3006050DAT	300 2400 / St / FS	5244585	7424 54 2		234						
OKA-W3006050R	300 2400 / St / FS	5244431	7424 48 2		234	OKB IE 25085	250 93 / St / FS	5699576	7403 82 5		248
OKA-W40010050	400 2400 / St / FS	5244301	7424 44 4		233	OKB IT	/ St / FS	5699699	7403 85 0		249
OKA-W40010050D4	400 2400 / St / FS	5244721	7424 62 2		235						
OKA-W40010050D6	400 2400 / St / FS	5244783	7424 68 2		236	OKB TS 25085	250 93 / St / FS	5699590	7403 83 5		248
OKA-W40010050D9	400 2400 / St / FS	5244912	7424 74 0		236					/m	
OKA-W40010050DAT	400 2400 / St / FS	5244646	7424 56 4		235						
OKA-W40010050DR9	400 2400 / St / FS	5245049	7424 80 0		237	OKB TW 85	240 / St / FS	5699606	7403 84 0		249
OKA-W40010050R	400 2400 / St / FS	5244493	7424 50 4		234						
OKA-W4004030	400 2400 / St / FS	5244141	7424 40 4		261	OKB U 25085 BL	250 93 / St / FS	5699552	7403 81 5		248
OKA-W4004030	400 2400 / St / FS	5244141	7424 40 4		233					/pc.	
OKA-W4004030D9	400 2400 / St / FS	5244837	7424 70 0		236						
OKA-W4004030DAT	400 2400 / St / FS	5244547	7424 52 4		234	OKB V 210	/ St / FS	5699712	7403 86 0		249
OKA-W4004030DR9	400 2400 / St / FS	5244967	7424 76 0		237						
OKA-W4004030R	400 2400 / St / FS	5244370	7424 46 4		233	OKB V 250	/ St / FS	5699705	7403 85 5		249
OKA-W4006050	400 2400 / St / FS	5244233	7424 42 4		233						
OKA-W4006050D4	400 2400 / St / FS	5244684	7424 60 2		235	RK M2 10	324 288 / CuZn	5105640	7405 84 4		318
OKA-W4006050D6	400 2400 / St / FS	5244752	7424 66 2		235						
OKA-W4006050D9	400 2400 / St / FS	5244868	7424 72 0		236	RK M2 15	324 288 / CuZn	5105657	7405 84 8		318
OKA-W4006050DR9	400 2400 / St / FS	5244868	7424 72 0		236						
OKA-W4006050R	400 2400 / St / FS	5244592	7424 54 4		234	RK M2 20	324 288 / CuZn	5105664	7405 85 2		318
OKA-W4006050DAT	400 2400 / St / FS	5245018	7424 78 0		237						
OKA-W4006050DR9	400 2400 / St / FS	5245018	7424 78 0		237	RK M2 25	324 288 / CuZn	5105695	7405 85 6		318
OKA-W4006050R	400 2400 / St / FS	5244448	7424 48 4		234						
OKA-W50010050	500 2400 / St / FS	5244318	7424 44 6		233	RK M3 10	424 388 / CuZn	5105725	7405 86 8		318
OKA-W50010050D4	500 2400 / St / FS	5244738	7424 62 4		235						
OKA-W50010050D6	500 2400 / St / FS	5244790	7424 68 4		236	RK M3 15	424 388 / CuZn	5105756	7405 87 2		318
OKA-W50010050D9	500 2400 / St / FS	5244929	7424 74 2		236						
OKA-W50010050DAT	500 2400 / St / FS	5244653	7424 56 6		235	RK M3 20	424 388 / CuZn	5105763	7405 87 6		318
OKA-W50010050DR9	500 2400 / St / FS	5245070	7424 80 2		237						
OKA-W50010050R	500 2400 / St / FS	5244509	7424 50 6		234	RK M3 25	424 388 / CuZn	5105770	7405 88 0		318
OKA-W5004030	500 2400 / St / FS	5244172	7424 40 6		261						
OKA-W5004030	500 2400 / St / FS	5244172	7424 40 6		233	RK NEV 110	/ St / G	5108221	7406 39 4		322
OKA-W5004030D9	500 2400 / St / FS	5244844	7424 70 2		236						
OKA-W5004030DAT	500 2400 / St / FS	5244554	7424 52 6		234	RK NEV 110	/ St / G	5108221	7406 39 4		343
OKA-W5004030DR9	500 2400 / St / FS	5244974	7424 76 2		237	RK NEV 110	/ St / G	5108221	7406 39 4		345
OKA-W5004030R	500 2400 / St / FS	5244387	7424 46 6		233	RK NEV 150	/ St / G	5108238	7406 39 8		322
						RK NEV 150	/ St / G	5108238	7406 39 8		326

08 UFS_Katalog_2010_Neuer_Stand / en / 25/02/2010 (LLEExport_00997)

Type	Dimensions/Colour/Div.	EAN-C.	Art. no.	Price	Page	Type	Dimensions/Colour/Div.	EAN-C.	Art. no.	Price	Page
RK NEV 150	/ St / G	5108238	7406 39 8	/pc.	343	RKFN 4 VMSL1N 15	/ V2A	5483397	7406 24 5	/pc.	344
RK NEV 150	/ St / G	5108238	7406 39 8		345	RKFN 4 VMSL1N 20	/ V2A	5483403	7406 24 6		344
						RKFN 4 VS 20	/ V2A	5107453	7406 24 0		322
RK SL1 V2 20	324 288 / V2A	5105824	7405 89 2		340	RKFN 4 VS 25	/ V2A	5107460	7406 24 4		322
RK SL1 V2 25	324 288 / V2A	5105831	7405 89 6		340						
RK SL1 V2 30	324 288 / V2A	5105848	7405 90 0		340	RKFN 9 MS 20	/ CuZn	5107507	7406 24 8		322
RK SL1 V2 40	324 288 / V2A	5105886	7405 90 8		340	RKFN 9 MS 25	/ CuZn	5107514	7406 25 2		322
RK SL1 V3 20	424 388 / V2A	5105893	7405 91 2		340						
RK SL1 V3 25	424 388 / V2A	5105909	7405 91 6		340	RKFN 9 VMSL1N 16	/ V2A	5483410	7406 26 1		344
RK SL1 V3 30	424 388 / V2A	5105930	7405 92 0		340	RKFN 9 VMSL1N 21	/ V2A	5483427	7406 26 2		344
RK SL1 V3 40	424 388 / V2A	5105954	7405 92 8		340	RKFN 9 VS 20	/ V2A	5107521	7406 25 6		322
						RKFN 9 VS 25	/ V2A	5107569	7406 26 0		322
RK SL2 V2 20	324 288 / V2A	5105961	7405 93 2		340						
RK SL2 V2 25	324 288 / V2A	5105992	7405 93 6		340	RKFN UZD3 4 MS20	90 / CuZn	5432159	7410 30 1		328
RK SL2 V2 30	324 288 / V2A	5106005	7405 94 0		340	RKFN UZD3 4 MS25	95 / CuZn	5432166	7410 30 5		328
RK SL2 V2 40	324 288 / V2A	5106029	7405 94 8		340	RKFN UZD3 4 VS20	90 / V2A	5432135	7410 29 2		328
RK SL2 V3 20	424 388 / V2A	5106050	7405 95 2		340	RKFN UZD3 4 VS25	95 / V2A	5432142	7410 29 6		328
RK SL2 V3 25	424 388 / V2A	5106067	7405 95 6		340	RKFN UZD3 9 MS20	90 / CuZn	5432210	7410 31 9		329
RK SL2 V3 30	424 388 / V2A	5106074	7405 96 0		340	RKFN UZD3 9 MS25	95 / CuZn	5432227	7410 32 3		329
RK SL2 V3 40	424 388 / V2A	5106111	7405 96 8		340						
						RKFN UZD3 9 VS20	90 / V2A	5432173	7410 31 0		329
RK V2 10	324 288 / V2A	5106258	7406 00 0		318	RKFN UZD3 9 VS25	95 / V2A	5432180	7410 31 4		329
RK V2 15	324 288 / V2A	5106265	7406 00 4		318	RKFR 4 M 20	/ CuZn	5107637	7406 27 6		325
						RKFR 4 M 25	/ CuZn	5107644	7406 28 0		325
RK V2 20	324 288 / V2A	5106302	7406 00 8		318						
						RKFR 4 SL2 V2 20	/ V2A	5107699	7406 28 8		342
RK V2 25	324 288 / V2A	5106319	7406 01 2		318	RKFR 4 SL2 V2 25	/ V2A	5107705	7406 29 2		342
RK V3 10	424 388 / V2A	5106388	7406 02 8		318	RKFR 4 V 20	/ V2A	5107743	7406 29 6		324
						RKFR 4 V 25	/ V2A	5107750	7406 30 0		324
RK V3 15	424 388 / V2A	5106425	7406 03 2		318						
						RKFR 7 M 20	/ CuZn	5107767	7406 30 4		325
RK V3 20	424 388 / V2A	5106432	7406 03 6		318	RKFR 7 M 25	/ CuZn	5107798	7406 30 8		325
RK V3 25	424 388 / V2A	5106449	7406 04 0		318	RKFR 7 SL2 V2 20	/ V2A	5107804	7406 31 2		342
						RKFR 7 SL2 V2 25	/ V2A	5107811	7406 31 6		342
RKF 2M2 10	324 288 / CuZn	5107026	7406 15 2		319						
RKF 2M2 15	324 288 / CuZn	5107033	7406 15 6		319	RKFR 7 V 20	/ V2A	5107828	7406 32 0		325
RKF 2M2 20	324 288 / CuZn	5107040	7406 16 0		319	RKFR 7 V 25	/ V2A	5107866	7406 32 4		325
RKF 2M2 25	324 288 / CuZn	5107088	7406 16 4		319						
						RKFR 9 M 20	/ CuZn	5107873	7406 32 8		325
RKF 2M3 10	424 388 / CuZn	5107095	7406 16 8		319	RKFR 9 M 25	/ CuZn	5107880	7406 33 2		325
RKF 2M3 15	424 388 / CuZn	5107101	7406 17 2		319						
RKF 2M3 20	424 388 / CuZn	5107149	7406 17 6		319	RKFR 9 SL2 V2 20	/ V2A	5107989	7406 34 8		342
RKF 2M3 25	424 388 / CuZn	5107156	7406 18 0		319	RKFR 9 SL2 V2 25	/ V2A	5107996	7406 35 2		342
RKF 2V2 10	324 288 / V2A	5107262	7406 20 0		319	RKFR 9V 20	/ V2A	5108009	7406 35 6		325
RKF 2V2 15	324 288 / V2A	5107279	7406 20 4		319	RKFR 9V 25	/ V2A	5108047	7406 36 0		325
RKF 2V2 20	324 288 / V2A	5107286	7406 20 8		319						
						RKFRNUZD3R4MS20	94 / CuZn	5432609	7410 47 6		332
RKF SL1 V2 20	324 288 / V2A	5106548	7406 05 6		340	RKFRNUZD3R4MS25	94 / CuZn	5432630	7410 48 0		332
RKF SL1 V2 25	324 288 / V2A	5106555	7406 06 0		340	RKFRNUZD3R4VS20	94 / V2A	5432586	7410 46 7		332
RKF SL1 V2 30	324 288 / V2A	5106562	7406 06 4		340	RKFRNUZD3R4VS25	94 / V2A	5432593	7410 47 1		332
RKF SL1 V2 40	324 288 / V2A	5106616	7406 07 2		340	RKFRNUZD3R7MS20	94 / CuZn	5432661	7410 49 4		332
RKF SL1 V3 20	424 388 / V2A	5106623	7406 07 6		340	RKFRNUZD3R7MS25	94 / CuZn	5432708	7410 49 8		332
RKF SL1 V3 25	424 388 / V2A	5106661	7406 08 0		340	RKFRNUZD3R7VS20	94 / V2A	5432647	7410 48 5		332
RKF SL1 V3 30	424 388 / V2A	5106678	7406 08 4		340	RKFRNUZD3R7VS25	94 / V2A	5432654	7410 48 9		332
RKF SL1 V3 40	424 388 / V2A	5106722	7406 09 2		340	RKFRNUZD3R9MS20	94 / CuZn	5432739	7410 51 2		333
						RKFRNUZD3R9MS25	94 / CuZn	5432746	7410 51 6		333
RKF SL2 V2 20	324 288 / V2A	5106739	7406 09 6		341	RKFRNUZD3R9VS20	94 / V2A	5432715	7410 50 3		332
RKF SL2 V2 25	324 288 / V2A	5106746	7406 10 0		341	RKFRNUZD3R9VS25	94 / V2A	5432722	7410 50 7		332
RKF SL2 V2 30	324 288 / V2A	5106784	7406 10 4		341						
RKF SL2 V2 40	324 288 / V2A	5106807	7406 11 2		341	RKN 4 MS 20	/ CuZn	5108054	7406 36 4		321
RKF SL2 V3 20	424 388 / V2A	5106845	7406 11 6		341	RKN 4 MS 25	/ CuZn	5108061	7406 36 8		321
RKF SL2 V3 25	424 388 / V2A	5106852	7406 12 0		341						
RKF SL2 V3 30	424 388 / V2A	5106869	7406 12 4		341	RKN 4 VMSL1N 15	/ V2A	5483458	7406 37 5		344
RKF SL2 V3 40	424 388 / V2A	5106913	7406 13 2		341	RKN 4 VMSL1N 20	/ V2A	5483465	7406 37 6		344
RKF2V2 25	324 288 / V2A	5107323	7406 21 2		319	RKN 4 VS 20	/ V2A	5108108	7406 37 0		321
						RKN 4 VS 25	/ V2A	5108115	7406 37 4		321
RKF2V3 10	424 388 / V2A	5107330	7406 21 6		319						
RKF2V3 15	424 388 / V2A	5107347	7406 22 0		319	RKN 9 MS 20	/ CuZn	5108122	7406 37 8		321
						RKN 9 MS 25	/ CuZn	5108160	7406 38 2		321
RKF2V3 20	424 388 / V2A	5107385	7406 22 4		319						
RKF2V3 25	424 388 / V2A	5107392	7406 22 8		319	RKN 9 VMSL1N 16	/ V2A	5483472	7406 39 1		344
						RKN 9 VMSL1N 21	/ V2A	5483489	7406 39 2		344
RKFN 4 MS 20	/ CuZn	5107408	7406 23 2		322						
RKFN 4 MS 25	/ CuZn	5107446	7406 23 6		322	RKN 9 VS 20	/ V2A	5108177	7406 38 6		321
						RKN 9 VS 25	/ V2A	5108184	7406 39 0		321

Type listing

Structure of the EAN number: Country code **40**

Manufacturer code **1219** (for articles beginning with **0: 1010**)

Individual EAN-C **5647589**

Type	Dimensions/Colour/Div.	EAN-C.	Art. no.	Price	Page	Type	Dimensions/Colour/Div.	EAN-C.	Art. no.	Price	Page
RKN UZD3 4MS20	90/ CuZn	5431978	7410 20 9	/pc.	327	RKS R9 V20	/ V2A	5109242	7406 65 4	/pc.	324
RKN UZD3 4MS25	95/ CuZn	5431985	7410 21 3		327	RKS R9 V25	/ V2A	5109259	7406 65 8		324
RKN UZD3 4VS20	90/ V2A	5431954	7410 20 0		327						
RKN UZD3 4VS25	95/ V2A	5431961	7410 20 4		327	RKS V3 15	424 388/ V2A	5108719	7406 52 6		319
RKN UZD3 9MS20	90/ CuZn	5432012	7410 22 7		327						
RKN UZD3 9MS25	95/ CuZn	5432029	7410 23 1		327	RKS V3 20	424 388/ V2A	5108726	7406 53 0		319
RKN UZD3 9VS20	90/ V2A	5431992	7410 21 8		327	RKS V3 25	424 388/ V2A	5108757	7406 53 4		319
RKN UZD3 9VS25	95/ V2A	5432005	7410 22 2		327						
RKR 4 SL2 V2 20	/ V2A	5108337	7406 42 2		342	RKSN 4 MS 20	/ CuZn	5108825	7406 56 2		321
RKR 4 SL2 V2 25	/ V2A	5108344	7406 42 6		342	RKSN 4 MS 25	/ CuZn	5108863	7406 56 6		321
						RKSN 4 VS 20	/ V2A	5108870	7406 57 0		321
RKR 4M 20	/ CuZn	5108290	7406 41 4		323	RKSN 4 VS 25	/ V2A	5108887	7406 57 4		321
RKR 4M 25	/ CuZn	5108306	7406 41 8		323						
						RKSN 9 MS 20	/ CuZn	5108924	7406 57 8		322
RKR 4V 20	/ V2A	5108351	7406 43 0		323	RKSN 9 MS 25	/ CuZn	5108931	7406 58 2		322
RKR 4V 25	/ V2A	5108368	7406 43 4		323						
						RKSN UZD3 4MS20	90/ CuZn	5432050	7410 25 5		328
RKR 7 SL2 V2 20	/ V2A	5108412	7406 44 6		342	RKSN UZD3 4MS25	95/ CuZn	5432067	7410 25 9		328
RKR 7 SL2 V2 25	/ V2A	5108429	7406 45 0		342	RKSN UZD3 4VS20	90/ V2A	5432036	7410 24 6		327
						RKSN UZD3 4VS25	95/ V2A	5432043	7410 25 0		327
RKR 7M 20	/ CuZn	5108399	7406 43 8		323	RKSN UZD3 9MS20	90/ CuZn	5432111	7410 27 3		328
RKR 7M 25	/ CuZn	5108405	7406 44 2		323	RKSN UZD3 9MS25	95/ CuZn	5432128	7410 27 7		328
						RKSN UZD3 9VS20	90/ V2A	5432098	7410 26 4		328
RKR 7V 20	/ V2A	5108450	7406 45 4		323	RKSN UZD3 9VS25	95/ V2A	5432104	7410 26 8		328
RKR 7V 25	/ V2A	5108467	7406 45 8		323						
						RKSRNUZD3R4MS20	94/ CuZn	5432425	7410 41 2		331
RKR 9 SL2 V2 20	/ V2A	5108528	7406 47 4		342	RKSRNUZD3R4MS25	94/ CuZn	5432456	7410 41 6		331
RKR 9 SL2 V2 25	/ V2A	5108535	7406 47 8		342	RKSRNUZD3R7MS20	94/ CuZn	5432487	7410 43 0		331
						RKSRNUZD3R7MS25	94/ CuZn	5432517	7410 43 4		331
RKR 9M 20	/ CuZn	5108474	7406 46 2		323	RKSRNUZD3R7VS20	94/ V2A	5432463	7410 42 1		331
RKR 9M 25	/ CuZn	5108481	7406 46 6		323	RKSRNUZD3R7VS25	94/ V2A	5432470	7410 42 5		331
						RKSRNUZD3R9MS20	94/ CuZn	5432548	7410 44 8		331
RKR 9V 20	/ V2A	5108542	7406 48 2		323	RKSRNUZD3R9MS25	94/ CuZn	5432579	7410 45 2		331
RKR 9V 25	/ V2A	5108573	7406 48 6		323	RKSRNUZD3R9VS20	94/ V2A	5432524	7410 43 9		331
						RKSRNUZD3R9VS25	94/ V2A	5432531	7410 44 3		331
RKRNUZD3R4MS20	94/ CuZn	5432289	7410 34 7		330						
RKRNUZD3R4MS25	94/ CuZn	5432296	7410 35 1		330					/m	
RKRNUZD3R4VS20	94/ V2A	5432234	7410 33 8		330	S2 19028	80 110/ St / FS	5089254	7400 30 0		206
RKRNUZD3R4VS25	94/ V2A	5432241	7410 34 2		330						
RKRNUZD3R7MS20	94/ CuZn	5432326	7410 36 5		330	S2 19038	80 110/ St / FS	5089261	7400 30 4		208
RKRNUZD3R7MS25	94/ CuZn	5432333	7410 36 9		330						
RKRNUZD3R7VS20	94/ V2A	5432302	7410 35 6		330	S2 19048	80 110/ St / FS	5089278	7400 30 8		210
RKRNUZD3R7VS25	94/ V2A	5432319	7410 36 0		330						
RKRNUZD3R9MS20	94/ CuZn	5432364	7410 38 4		330	S2 25028	110 140/ St / FS	5089285	7400 31 2		206
RKRNUZD3R9MS25	94/ CuZn	5432395	7410 38 8		330						
RKRNUZD3R9VS20	94/ V2A	5432340	7410 37 4		330	S2 25038	110 140/ St / FS	5089315	7400 31 6		208
RKRNUZD3R9VS25	94/ V2A	5432357	7410 37 9		330						
						S2 25048	110 140/ St / FS	5089322	7400 32 0		210
RKS 2M2 15	324 288/ CuZn	5108764	7406 53 8		318						
RKS 2M2 20	324 288/ CuZn	5108771	7406 54 2		318	S3 25028	90 70/ St / FS	5089339	7400 32 4		206
RKS 2M2 25	324 288/ CuZn	5108788	7406 54 6		318						
						S3 25038	90 70/ St / FS	5089346	7400 32 8		208
RKS 2V2 15	324 288/ V2A	5108795	7406 55 0		318						
RKS 2V2 20	324 288/ V2A	5108801	7406 55 4		318	S3 25048	90 70/ St / FS	5089377	7400 33 2		210
RKS 2V2 25	324 288/ V2A	5108818	7406 55 8		318						
						S3 35028	120 110/ St / FS	5089384	7400 33 6		206
RKS M3 15	424 388/ CuZn	5108634	7406 50 2		319						
						S3 35038	120 110/ St / FS	5089391	7400 34 0		208
RKS M3 20	424 388/ CuZn	5108641	7406 50 6		319						
RKS M3 25	424 388/ CuZn	5108658	7406 51 0		319	S3 35048	120 110/ St / FS	5089407	7400 34 4		210
RKS NV 9 20	/ V2A	5109006	7406 59 8		321						
RKS NV 9 25	/ V2A	5109051	7406 60 2		321	S990-AF1 RW	Pure white/ PC	5120957	6107 00 2	/pc.	365
RKS R4 M20	/ CuZn	5109068	7406 60 6		324	S990-AF2 RW	Pure white/ PC	5121084	6107 10 2		365
RKS R4 M25	/ CuZn	5109075	7406 61 0		324						
						S990-AF3 RW	Pure white/ PC	5121244	6107 20 2		365
RKS R4 V20	/ V2A	5109082	7406 61 4		323						
RKS R4 V25	/ V2A	5109112	7406 61 8		323	S990-AFB1 RW	Pure white/ PC	5121022	6107 05 2		365
						S990-AFB2 RW	Pure white/ PC	5121183	6107 15 2		365
RKS R7 M20	/ CuZn	5109136	7406 62 6		324	S990-AFB3 RW	Pure white/ PC	5121305	6107 25 2		365
RKS R7 M25	/ CuZn	5109143	7406 63 0		324						
RKS R7 V20	/ V2A	5109174	7406 63 4		324						
RKS R7 V25	/ V2A	5109181	7406 63 8		324	SAK 1019	Grey-beige/ PA	5113683	7407 98 4		334
RKS R9 M20	/ CuZn	5109204	7406 64 6		324	SAK 7011	Grey/ PA	5113645	7407 97 6		334
RKS R9 M25	/ CuZn	5109235	7406 65 0		324	SAK 8014	Sepia brown/ PA	5113690	7407 98 8		334

08_UFS_Katalog_2010_Neuer_Stand / en / 25/02/2010 (LLEExport_00997)

Type	Dimensions/Colour/Div.	EAN-C.	Art. no.	Price	Page	Type	Dimensions/Colour/Div.	EAN-C.	Art. no.	Price	Page
SAK 9011	Graphite black/ PA	5113676	7407 98 0	/pc.	334	SH80 7011	Grey/ PA	5113812	7408 02 0	/pc.	373
SAK MS	/ CuZn	5113706	7407 99 2		334	SH80 8014	Sepia brown/ PA	5113867	7408 03 2		373
SAK V2A	/ V2A	5113737	7407 99 6		334	SH80 9011	Graphite black/ PA	5113829	7408 02 4		373
SE UZD3		5431886	7410 16 0		221	SH80 T 1019	Grey-beige/ PA	5113928	7408 04 8		373
SE2 19027	190 2400/ St / FS	5098515	7403 90 0	/m	270	SH80 T 7011	Grey/ PA	5113881	7408 04 0		373
SE2 19037	190 2400/ St / FS	5098522	7403 90 4		272	SH80 T 8014	Sepia brown/ PA	5113935	7408 05 2		373
SE2 19047	190 2400/ St / FS	5098553	7403 90 8		274	SH80 T 9011	Graphite black/ PA	5113911	7408 04 4		373
SE2 25027	250 2400/ St / FS	5098560	7403 91 2		270	SHF80 30 1019	Grey-beige/ PA	5113973	7408 06 0		373
SE2 25037	250 2400/ St / FS	5098577	7403 91 6		272	SHF80 30 9011	Graphite black/ PA	5113942	7408 05 6		373
SE2 25047	250 2400/ St / FS	5098584	7403 92 0		274	SHF80 30M 9011	Graphite black/ PA	5113980	7408 06 4		373
SE3 19037	190 2400/ St / FS	5098614	7403 92 2		272	SK HB 201X201	201/ PS	5246435	7425 60 0		394
SE3 19047	190 2400/ St / FS	5098621	7403 92 4		274	SK HB 245X245	245/ PS	5099901	7404 41 2		394
SE3 25027	250 2400/ St / FS	5098638	7403 92 8		270	SK HB R215	215/ PS	5099871	7404 40 0		394
SE3 25037	250 2400/ St / FS	5098645	7403 93 2		272	SK HB R275	275/ PS	5099888	7404 40 4		394
SE3 25047	250 2400/ St / FS	5098676	7403 93 6		274	SK HB R305	305/ PS	5099895	7404 40 8		394
SEG2 19027	190 2400/ St / FS	5098683	7403 94 0		270	SKS-CH0 RW1	Pure white/ PC	5008866	6117 20 0		400
SEG2 19037	190 2400/ St / FS	5098690	7403 94 4		272	SKS-D0 MZGN1	Mint green/ PC	6458530	6117 00 5		265
SEG2 19047	190 2400/ St / FS	5098706	7403 94 8		274	SKS-D0 MZGN1	Mint green/ PC	6458530	6117 00 5		312
SEG2 25027	250 2400/ St / FS	5098737	7403 95 2		270	SKS-D0 MZGN1	Mint green/ PC	6458530	6117 00 5		398
SEG2 25037	250 2400/ St / FS	5098744	7403 95 6		272	SKS-D0 MZGN2	Mint green/ PC	6458837	6117 01 6		266
SEG2 25047	250 2400/ St / FS	5098751	7403 96 0		274	SKS-D0 MZGN2	Mint green/ PC	6458837	6117 01 6		313
SEG3 19037	190 2400/ St / FS	5098768	7403 96 4		272	SKS-D0 MZGN2	Mint green/ PC	6458837	6117 01 6		398
SEG3 19047	190 2400/ St / FS	5098799	7403 96 8		274	SKS-D0 MZGN3	Mint green/ PC	6458950	6117 02 7		266
SEG3 25027	250 2400/ St / FS	5098805	7403 97 2		270	SKS-D0 MZGN3	Mint green/ PC	6458950	6117 02 7		313
SEG3 25037	250 2400/ St / FS	5098812	7403 97 6		272	SKS-D0 MZGN3	Mint green/ PC	6458950	6117 02 7		398
SES 19027	190 27/ St / FS	5098829	7403 98 0	/pc.	206	SKS-D0 ROR1	Orange/ PC	6458356	6117 00 3		265
SES 19037	190 37/ St / FS	5098850	7403 98 4		208	SKS-D0 ROR1	Orange/ PC	6458356	6117 00 3		312
SES 19047	190 48/ St / FS	5098867	7403 98 8		210	SKS-D0 ROR1	Orange/ PC	6458356	6117 00 3		398
SES 25027	250 27/ St / FS	5098874	7404 00 2		206	SKS-D0 ROR2	Orange/ PC	6458653	6117 01 4		266
SES 25037	250 37/ St / FS	5098881	7404 00 6		208	SKS-D0 ROR2	Orange/ PC	6458653	6117 01 4		313
SES 25047	250 48/ St / FS	5098911	7404 01 0		210	SKS-D0 ROR2	Orange/ PC	6458653	6117 01 4		398
SES 35027	350 27/ St / FS	5098928	7404 01 4		206	SKS-D0 ROR3	Orange/ PC	6645077	6117 02 5		266
SES 35037	350 37/ St / FS	5098935	7404 01 8		208	SKS-D0 ROR3	Orange/ PC	6645077	6117 02 5		313
SES 35047	350 48/ St / FS	5098942	7404 02 2		210	SKS-D0 ROR3	Orange/ PC	6645077	6117 02 5		398
SG TW	/ PA	5303770	7429 17 0		353	SKS-D0 RW1	Pure white/ PC	6458295	6117 00 1		265
SG1	/ PA	5303718	7429 16 0		352	SKS-D0 RW1	Pure white/ PC	6458295	6117 00 1		312
SG2	/ PA	5303725	7429 16 2		352	SKS-D0 RW1	Pure white/ PC	6458295	6117 00 1		398
SG3	/ PA	5303763	7429 16 4		353	SKS-D0 RW2	Pure white/ PC	6518531	6117 01 2		266
SGH 50		6020652	7368 59 3		335	SKS-D0 RW2	Pure white/ PC	6518531	6117 01 2		313
SH80 1019	Grey-beige/ PA	5113850	7408 02 8		373	SKS-D0 RW2	Pure white/ PC	6518531	6117 01 2		398
						SKS-D0 RW3	Pure white/ PC	6458899	6117 02 3		266
						SKS-D0 RW3	Pure white/ PC	6458899	6117 02 3		313
						SKS-D0 SRO1	Signal red/ PC	6458592	6117 00 7		265
						SKS-D0 SRO1	Signal red/ PC	6458592	6117 00 7		312
						SKS-D0 SRO1	Signal red/ PC	6458592	6117 00 7		398
						SKS-D0 SRO2	Signal red/ PC	6471072	6117 01 8		266
						SKS-D0 SRO2	Signal red/ PC	6471072	6117 01 8		313
						SKS-D0 SRO2	Signal red/ PC	6471072	6117 01 8		398
						SKS-D0 SRO3	Signal red/ PC	6597376	6117 02 9		266
						SKS-D0 SRO3	Signal red/ PC	6597376	6117 02 9		313
						SKS-D0 SRO3	Signal red/ PC	6597376	6117 02 9		398
						SKS-D3 AL1	Aluminium paint/ PC	6213139	6117 04 9		398
						SKS-D3 AL2	Aluminium paint/ PC	6213191	6117 06 0		398
						SKS-D3 AL3	Aluminium paint/ PC	6213436	6117 07 1		398
						SKS-D3 MZGN1	Mint green/ PC	6459131	6117 04 5		255
						SKS-D3 MZGN1	Mint green/ PC	6459131	6117 04 5		266
						SKS-D3 MZGN1	Mint green/ PC	6459131	6117 04 5		313
						SKS-D3 MZGN1	Mint green/ PC	6459131	6117 04 5		353
						SKS-D3 MZGN1	Mint green/ PC	6459131	6117 04 5		398
						SKS-D3 MZGN2	Mint green/ PC	6459674	6117 05 6		255

Type listing

Structure of the EAN number: Country code **40**

Manufacturer code **1219** (for articles beginning with **0: 1010**)

Individual EAN-C **5647589**

Type	Dimensions/Colour/Div.	EAN-C.	Art. no.	Price	Page	Type	Dimensions/Colour/Div.	EAN-C.	Art. no.	Price	Page
SKS-D3 MZGN2	Mint green / PC	6459674	6117 05 6	/pc.	266	SKS-DS3 SRO2	Signal red / PC	5437970	6117 08 0	/pc.	386
SKS-D3 MZGN2	Mint green / PC	6459674	6117 05 6		313	SKS-DS3 SRO3	Signal red / PC	5670896	6119 85 6		250
SKS-D3 MZGN2	Mint green / PC	6459674	6117 05 6		353	SKS-DS3 SRO3	Signal red / PC	5670896	6119 85 6		386
SKS-D3 MZGN2	Mint green / PC	6459674	6117 05 6		398	SKS-DS3 SWGR3	Black-grey / PC	5670902	6119 85 8		250
SKS-D3 MZGN3	Mint green / PC	6459971	6117 06 7		255	SKS-DS3 SWGR3	Black-grey / PC	5670902	6119 85 8		386
SKS-D3 MZGN3	Mint green / PC	6459971	6117 06 7		266						
SKS-D3 MZGN3	Mint green / PC	6459971	6117 06 7		313						
SKS-D3 MZGN3	Mint green / PC	6459971	6117 06 7		353	SKS-F0 MZGN1	Mint green / PC	6460212	6117 10 6		399
SKS-D3 MZGN3	Mint green / PC	6459971	6117 06 7		398	SKS-F0 MZGN2	Mint green / PC	6188956	6117 11 5		399
SKS-D3 MZGN3	Mint green / PC	6459971	6117 06 7			SKS-F0 MZGN3	Mint green / PC	6189373	6117 12 7		399
SKS-D3 ROR1	Orange / PC	6459070	6117 04 3		255						
SKS-D3 ROR1	Orange / PC	6459070	6117 04 3		266	SKS-F0 ROR1	Orange / PC	6460151	6117 10 4		399
SKS-D3 ROR1	Orange / PC	6459070	6117 04 3		313	SKS-F0 ROR2	Orange / PC	6460458	6117 11 3		399
SKS-D3 ROR1	Orange / PC	6459070	6117 04 3		353	SKS-F0 ROR3	Orange / PC	6189311	6117 12 5		399
SKS-D3 ROR1	Orange / PC	6459070	6117 04 3		398	SKS-F0 RW1	Pure white / PC	6460090	6117 10 2		399
SKS-D3 ROR2	Orange / PC	6459612	6117 05 4		255	SKS-F0 RW2	Pure white / PC	6460335	6117 11 1		399
SKS-D3 ROR2	Orange / PC	6459612	6117 05 4		266	SKS-F0 RW3	Pure white / PC	6189076	6117 12 3		399
SKS-D3 ROR2	Orange / PC	6459612	6117 05 4		313						
SKS-D3 ROR2	Orange / PC	6459612	6117 05 4		353	SKS-F0 SRO1	Signal red / PC	6460274	6117 10 8		399
SKS-D3 ROR2	Orange / PC	6459612	6117 05 4		398	SKS-F0 SRO2	Signal red / PC	6189014	6117 11 7		399
SKS-D3 ROR3	Orange / PC	6459858	6117 06 5		255	SKS-F0 SRO3	Signal red / PC	6189618	6117 12 9		399
SKS-D3 ROR3	Orange / PC	6459858	6117 06 5		266						
SKS-D3 ROR3	Orange / PC	6459858	6117 06 5		313	SKS-F3 AL1	Aluminium paint / PC	6213856	6117 14 8		399
SKS-D3 ROR3	Orange / PC	6459858	6117 06 5		353	SKS-F3 AL2	Aluminium paint / PC	6213917	6117 15 9		400
SKS-D3 ROR3	Orange / PC	6459858	6117 06 5		398	SKS-F3 AL3	Aluminium paint / PC	6213979	6117 17 0		400
SKS-D3 RW1	Pure white / PC	6459018	6117 04 1		255						
SKS-D3 RW1	Pure white / PC	6459018	6117 04 1		266	SKS-F3 MZGN1	Mint green / PC	6287291	6117 14 4		399
SKS-D3 RW1	Pure white / PC	6459018	6117 04 1		313	SKS-F3 MZGN2	Mint green / PC	6637218	6117 15 5		400
SKS-D3 RW1	Pure white / PC	6459018	6117 04 1		353	SKS-F3 MZGN3	Mint green / PC	6461356	6117 16 6		400
SKS-D3 RW1	Pure white / PC	6459018	6117 04 1		398						
SKS-D3 RW2	Pure white / PC	6459551	6117 05 2		255	SKS-F3 ROR1	Orange / PC	6189854	6117 14 2		399
SKS-D3 RW2	Pure white / PC	6459551	6117 05 2		266	SKS-F3 ROR2	Orange / PC	6538690	6117 15 3		400
SKS-D3 RW2	Pure white / PC	6459551	6117 05 2		313	SKS-F3 ROR3	Orange / PC	6461233	6117 16 4		400
SKS-D3 RW2	Pure white / PC	6459551	6117 05 2		353	SKS-F3 RW1	Pure white / PC	6189793	6117 14 0		399
SKS-D3 RW2	Pure white / PC	6459551	6117 05 2		398	SKS-F3 RW2	Pure white / PC	6460632	6117 15 1		400
SKS-D3 RW3	Pure white / PC	6459797	6117 06 3		255	SKS-F3 RW3	Pure white / PC	6461110	6117 16 2		400
SKS-D3 RW3	Pure white / PC	6459797	6117 06 3		266						
SKS-D3 RW3	Pure white / PC	6459797	6117 06 3		313	SKS-F3 SRO1	Signal red / PC	6287536	6117 14 6		399
SKS-D3 RW3	Pure white / PC	6459797	6117 06 3		353	SKS-F3 SRO2	Signal red / PC	6461059	6117 15 7		400
SKS-D3 RW3	Pure white / PC	6459797	6117 06 3		398	SKS-F3 SRO3	Signal red / PC	6461530	6117 16 8		400
SKS-D3 SRO1	Signal red / PC	6459377	6117 04 7		255						
SKS-D3 SRO1	Signal red / PC	6459377	6117 04 7		266	SKS-FC0 SRO1	Signal red / PC	5364184	6106 67 7		399
SKS-D3 SRO1	Signal red / PC	6459377	6117 04 7		313	SKS-FC0 SRO2	Signal red / PC	5364252	6106 68 7		399
SKS-D3 SRO1	Signal red / PC	6459377	6117 04 7		353	SKS-FC0 SRO3	Signal red / PC	5364368	6106 69 7		399
SKS-D3 SRO1	Signal red / PC	6459377	6117 04 7		398						
SKS-D3 SRO2	Signal red / PC	6459735	6117 05 8		255	SKS-FC3 SRO1	Signal red / PC	5364436	6106 70 7		400
SKS-D3 SRO2	Signal red / PC	6459735	6117 05 8		266	SKS-FC3 SRO2	Signal red / PC	5364504	6106 71 7		400
SKS-D3 SRO2	Signal red / PC	6459735	6117 05 8		313	SKS-FC3 SRO3	Signal red / PC	5364597	6106 72 7		400
SKS-D3 SRO2	Signal red / PC	6459735	6117 05 8		353						
SKS-D3 SRO2	Signal red / PC	6459735	6117 05 8		398	SRE 250 1019	Grey-beige / PA	5098997	7404 03 4		277
SKS-D3 SRO3	Signal red / PC	6460038	6117 06 9		255	SRE 250 7011	Grey / PA	5098973	7404 02 6		277
SKS-D3 SRO3	Signal red / PC	6460038	6117 06 9		266	SRE 250 8014	Sepia brown / PA	5098980	7404 03 0		277
SKS-D3 SRO3	Signal red / PC	6460038	6117 06 9		313	SRE 250 9011	Graphite black / PA	5099000	7404 03 8		277
SKS-D3 SRO3	Signal red / PC	6460038	6117 06 9		353						
SKS-D3 SRO3	Signal red / PC	6460038	6117 06 9		398						
SKS-DK0 RW1	Pure white / PC	5462231	6117 20 2		401	STA-SKS S1 SW	Black	5438090	6117 19 2		250
						STA-SKS SU1 SW	Black	5670933	6117 19 6		386
						STA-SKS SU1 W	White	5670940	6117 19 7		386
SKS-DKE0 RW1	Pure white / PC	5616016	6117 20 3		401	ST-F GST18i3p SW	Black	5273530	6108 05 0		392
SKS-DS3 AL2	Aluminium paint / PC	5437987	6117 08 2		250	ST-F GST18i3p W	White	5273547	6108 05 1		392
SKS-DS3 AL2	Aluminium paint / PC	5437987	6117 08 2		386						
SKS-DS3 AL3	Aluminium paint / PC	5670919	6119 86 0		250	ST-S GST18i3p SW	Black	5273608	6108 05 4		392
SKS-DS3 AL3	Aluminium paint / PC	5670919	6119 86 0		386	ST-S GST18i3p W	White	5273646	6108 05 5		392
SKS-DS3 MZGN2	Mint green / PC	5437949	6117 07 8		250						
SKS-DS3 MZGN2	Mint green / PC	5437949	6117 07 8		386	ST-S GST18i5p SW	Black	5273707	6108 07 0		393
SKS-DS3 MZGN3	Mint green / PC	5670889	6119 85 4		250						
SKS-DS3 MZGN3	Mint green / PC	5670889	6119 85 4		386						
SKS-DS3 ROR2	Orange / PC	5437932	6117 07 6		250	T EM	/ Zn	5114055	7408 08 4		271
SKS-DS3 ROR2	Orange / PC	5437932	6117 07 6		386	T EM	/ Zn	5114055	7408 08 4		273
SKS-DS3 ROR3	Orange / PC	5670872	6119 85 2		250	T EM	/ Zn	5114055	7408 08 4		275
SKS-DS3 ROR3	Orange / PC	5670872	6119 85 2		386	T EM	/ Zn	5114055	7408 08 4		293
SKS-DS3 RW2	Pure white / PC	5437925	6117 07 4		250	T EM	/ Zn	5114055	7408 08 4		296
SKS-DS3 RW2	Pure white / PC	5437925	6117 07 4		386	T EM	/ Zn	5114055	7408 08 4		368
SKS-DS3 RW3	Pure white / PC	5670865	6119 85 0		250						
SKS-DS3 RW3	Pure white / PC	5670865	6119 85 0		386	T ZE	/ PA	5114062	7408 08 8		368
SKS-DS3 SRO2	Signal red / PC	5437970	6117 08 0		250						

08 UFS_Katalog_2010_Neuer_Stand / en / 25/02/2010 (LLEExport_00997)

Type	Dimensions/Colour/Div.	EAN-C.	Art. no.	Price	Page	Type	Dimensions/Colour/Div.	EAN-C.	Art. no.	Price	Page
T12L 00C 7011	Grey/ PA	5114109	7408 09 6	/pc.	366	T8NL P3 7035	Light grey/ PA	5115861	7408 47 0	/pc.	364
T12L 00C 9011	Graphite black/ PA	5114116	7408 10 0		366	T8NL P3 9011	Graphite black/ PA	5115854	7408 46 4		364
T12L P01S 9011	Graphite black/ PVC	5114154	7408 10 8		366	T8NL P45 7035	Light grey/ PA	5115915	7408 47 8		364
T12L P02S 9011	Graphite black/ PVC	5114178	7408 11 6		366	T8NL P45 9011	Graphite black/ PA	5115908	7408 47 4		364
T12L P03S 9011	Graphite black/ PVC	5114215	7408 12 4		366	T8NL PCEE 7035	Light grey/ PA	5115960	7408 48 6		365
T12L P04S 9011	Graphite black/ PVC	5114239	7408 13 2		366	T8NL PCEE 9011	Graphite black/ PA	5115922	7408 48 2		365
T12L P05S 9011	Graphite black/ PVC	5114277	7408 14 0		366	T8NL TQ	Graphite black/ PVC	5115977	7408 49 0		365
T12L P15S 9011	Graphite black/ PA	5114291	7408 14 8		367	TAE-6F AL1	Aluminium paint	6215959	6117 43 0		402
T12L P16S 9011	Graphite black/ PA	5114338	7408 15 6		367	TAE-6F RW1	Pure white	6215713	6117 42 8		402
T12L P17S 9011	Graphite black/ PA	5114352	7408 16 4		367	TU GRAF9 7011	Grey/ PA	5116035	7408 50 2		310
T12L P1S 9011	Graphite black/ PVC	5114390	7408 17 2		367	TU GRAF9 9011	Graphite black/ PA	5116042	7408 50 6		310
T12L P2S 9011	Graphite black/ PVC	5114413	7408 18 0		367	TUK A	/ Al / MT	5116080	7408 51 0		334
T12L P3S 9011	Graphite black/ PVC	5114437	7408 18 8		367	TUK M 1019	Grey-beige/ PA	5116141	7408 52 2		334
T12L P4S 9011	Graphite black/ PVC	5114451	7408 19 6		367	TUK M 7011	Grey/ PA	5116097	7408 51 4		334
T12L P7S 9011	Graphite black/ PVC	5114536	7408 20 4		367	TUK M 8014	Sepia brown/ PA	5116158	7408 52 6		334
T12L TQ	Graphite black/ PVC	5114543	7408 20 8		368	TUK M 9011	Graphite black/ PA	5116103	7408 51 8		334
T4B 00C 7011	Grey/ PA	5114956	7408 28 8		362	TUK OA	/ Al	5299363	7428 45 0		334
T4B 00C 9011	Graphite black/ PA	5114963	7408 29 2		362	TUK V 7011	Grey/ PA	5116165	7408 53 0		334
T4B P01S 9011	Graphite black/ PVC	5114604	7408 22 0		362	TUK V 9011	Graphite black/ PA	5116202	7408 53 4		334
T4B P0S2 9011	Graphite black/ PVC	5114659	7408 22 8		362	UDB	/ St / G	5116271	7408 55 0		308
T4B P1S 9011	Graphite black/ PVC	5114703	7408 23 6		362	UDHOME4 M V	95/ CuZn	5246183	7427 00 6		383
T4B P2S 9011	Graphite black/ PVC	5114727	7408 24 4		362	UDHOME4 V V	95/ V2A	5246121	7427 00 0		383
T4B P3S 9011	Graphite black/ PVC	5114772	7408 25 2		362	UDHOME9 M GB V	95/ CuZn	5710844	7427 03 7		383
T4B P5S 9011	Graphite black/ PVC	5114826	7408 26 0		362	UDHOME9 V GB V	95/ V2A	5710837	7427 03 1		383
T4B P6 9011	Graphite black/ PA	5114840	7408 26 8		363	UDL1-120 70 90SL	70/ St / FS	5116288	7408 55 4		380
T4B P7 9011	Graphite black/ PA	5114895	7408 27 6		363	UDL2-120 70	/ St / FS	5116325	7408 55 8		380
T4B TQ	Graphite black/ PVC	5114901	7408 28 0		363	UDL2-120 80	/ St / FS	5116332	7408 56 2		380
T4L EG	Graphite black/ PA	5115007	7408 29 6		363	UDL2-80 70	/ St / FS	5116349	7408 56 6		372
T4L00C 9011	Graphite black/ PA	5115014	7408 30 0		363	UGD 250-3 4	367 410/ St / FS	5431701	7410 07 9		213
T4L00C7035	Light grey/ PA	5115021	7408 30 4		363	UGD 250-3 6	367 410/ St / FS	5431732	7410 08 3		213
T8NL 00C 7035	Light grey/ PA	5116028	7408 49 8		363	UGD 250-3 9	367 410/ St / FS	5431749	7410 08 7		213
T8NL 00C 9011	Graphite black/ PA	5115984	7408 49 4		363	UGD 250-3R4	367 410/ St / FS	5431756	7410 09 1		213
T8NL A105 9011	Graphite black/ PA	5115564	7408 41 2		364	UGD 350-3 4	467 201/ St / FS	5431763	7410 10 4		217
T8NL A45 9011	Graphite black/ PA	5115601	7408 41 6		363	UGD 350-3 6	467 201/ St / FS	5431770	7410 10 8		217
T8NL EB1 7035	Light grey/ PA	5115625	7408 42 4		366	UGD 350-3 9	467 244/ St / FS	5431787	7410 11 2		217
T8NL EB1 9011	Graphite black/ PA	5115618	7408 42 0		366	UGD 350-3 R4	467 510/ St / FS	5431794	7410 11 6		217
T8NL EB2 7035	Light grey/ PA	5115670	7408 43 2		365	UGD 350-3 R7	467 510/ St / FS	5431800	7410 12 0		217
T8NL EB2 9011	Graphite black/ PA	5115663	7408 42 8		365	UGD 350-3 R9	467 510/ St / FS	5431817	7410 12 4		217
T8NL P01 7035	Light grey/ PA	5115724	7408 44 0		364	UGD55 250-3 9R	367 410/ St / FS	5678724	7410 06 0		263
T8NL P01 9011	Graphite black/ PA	5115687	7408 43 6		364	UGD55 350-3 9R	467 467/ St / FS	5678762	7410 06 2		263
T8NL P1 7035	Light grey/ PA	5115748	7408 44 8		364	UGD55 350-3R9R	467 467/ St / FS	5678779	7410 06 4		263
T8NL P1 9011	Graphite black/ PA	5115731	7408 44 4		364	ULA DB 7011	Grey/ PA	5438717	7407 89 8		374
T8NL P105 7035	Light grey/ PA	5115793	7408 45 6		364	ULA DB SA 7011	Grey/ PA	5438694	7407 89 4		374
T8NL P105 9011	Graphite black/ PA	5115786	7408 45 2		364	ULA DB T 7011	Grey/ PA	5438700	7407 89 6		374
T8NL P2 7035	Light grey/ PA	5115847	7408 46 0		364	US80 32	/ Zn	5116387	7408 57 0		372
T8NL P2 9011	Graphite black/ PA	5115809	7408 45 8		364	US80 A	/ PA	5116462	7408 59 0		372
						US80 B	/ PA	5116509	7408 59 4		372

Type listing

Structure of the EAN number: Country code **40**

Manufacturer code **1219** (for articles beginning with **0: 1010**)

Individual EAN-C **5647589**

Type	Dimensions/Colour/Div.	EAN-C.	Art. no.	Price	Page	Type	Dimensions/Colour/Div.	EAN-C.	Art. no.	Price	Page
US80 DB 20	53/ Zn	5116400	7408 57 8	/pc.	372	VL-3Q1.5 10 W	White	5122876	6108 13 4	/pc.	390
US80 DB 38	77/ Zn	5116448	7408 58 2		372	VL-3Q1.5 11 SW	Black	5122517	6108 11 0		251
						VL-3Q1.5 11 SW	Black	5122517	6108 11 0		390
						VL-3Q1.5 11 W	White	5122883	6108 13 5		251
ÜSM-A-4		5613596	5092 47 2		401	VL-3Q1.5 11 W	White	5122883	6108 13 5		390
						VL-3Q1.5 12 SW	Black	5122524	6108 11 1		251
						VL-3Q1.5 12 SW	Black	5122524	6108 11 1		390
ÜSM-A-4T		5699767	6107 80 1		401	VL-3Q1.5 12 W	White	5122920	6108 13 6		251
						VL-3Q1.5 12 W	White	5122920	6108 13 6		390
						VL-3Q1.5 13 SW	Black	5122562	6108 11 2		251
USS80 W	/ Zn	5116523	7408 60 2		372	VL-3Q1.5 13 SW	Black	5122562	6108 11 2		390
						VL-3Q1.5 13 W	White	5122937	6108 13 7		251
						VL-3Q1.5 13 W	White	5122937	6108 13 7		390
						VL-3Q1.5 14 SW	Black	5122579	6108 11 3		251
UVS-6S2	/ ST	5122265	6108 00 0		389	VL-3Q1.5 14 SW	Black	5122579	6108 11 3		390
						VL-3Q1.5 14 W	White	5122944	6108 13 8		251
UVS-6S2SA	/ ST	5522997	6108 01 2		390	VL-3Q1.5 14 W	White	5122944	6108 13 8		390
						VL-3Q1.5 15 SW	Black	5122586	6108 11 4		251
						VL-3Q1.5 15 SW	Black	5122586	6108 11 4		390
UVS-6S6W2	/ ST	5122289	6108 01 0		389	VL-3Q1.5 15 W	White	5122982	6108 13 9		251
						VL-3Q1.5 15 W	White	5122982	6108 13 9		390
UVS-6S6W2SA	/ ST	5523017	6108 01 6		390	VL-3Q1.5 2 SW	Black	5122333	6108 10 1		251
						VL-3Q1.5 2 SW	Black	5122333	6108 10 1		390
						VL-3Q1.5 2 W	White	5122708	6108 12 6		251
UVS-6W2	/ ST	5122272	6108 00 5		389	VL-3Q1.5 2 W	White	5122708	6108 12 6		390
						VL-3Q1.5 3 SW	Black	5122340	6108 10 2		251
						VL-3Q1.5 3 SW	Black	5122340	6108 10 2		390
UVS-6W2SA	/ ST	5523000	6108 01 4		389	VL-3Q1.5 3 W	White	5122746	6108 12 7		251
						VL-3Q1.5 3 W	White	5122746	6108 12 7		390
						VL-3Q1.5 4 SW	Black	5122388	6108 10 3		251
UZD 115170 250-3	367 410/ St / FS	5431640	7410 04 3		213	VL-3Q1.5 4 SW	Black	5122388	6108 10 3		390
UZD 115170 350-3	467 510/ St / FS	5431671	7410 04 7		217	VL-3Q1.5 4 W	White	5122753	6108 12 8		251
						VL-3Q1.5 4 W	White	5122753	6108 12 8		390
UZD 165220 250-3	367 410/ St / FS	5431688	7410 05 2		213	VL-3Q1.5 5 SW	Black	5122395	6108 10 4		251
UZD 165220 350-3	467 510/ St / FS	5431695	7410 05 6		217	VL-3Q1.5 5 SW	Black	5122395	6108 10 4		390
						VL-3Q1.5 5 W	White	5122760	6108 12 9		251
UZD 250-3	367 410/ St / FS	5430964	7410 03 0		213	VL-3Q1.5 5 W	White	5122760	6108 12 9		390
UZD 250-3 R	367 410/ St / FS	5475507	7410 03 1		213	VL-3Q1.5 6 SW	Black	5122401	6108 10 5		251
						VL-3Q1.5 6 SW	Black	5122401	6108 10 5		390
UZD 350-3	467 510/ St / FS	5431633	7410 03 4		217	VL-3Q1.5 6 W	White	5122807	6108 13 0		251
UZD 350-3 R	467 510/ St / FS	5475545	7410 03 5		217	VL-3Q1.5 6 W	White	5122807	6108 13 0		390
						VL-3Q1.5 7 SW	Black	5122449	6108 10 6		251
VB-3 GST18i3p	Black	5273721	6108 08 0		393	VL-3Q1.5 7 SW	Black	5122449	6108 10 6		390
						VL-3Q1.5 7 W	White	5122814	6108 13 1		251
VB-5 GST18i3p	Black	5273769	6108 08 2		393	VL-3Q1.5 7 W	White	5122814	6108 13 1		390
						VL-3Q1.5 8 SW	Black	5122456	6108 10 7		251
						VL-3Q1.5 8 SW	Black	5122456	6108 10 7		390
VB-SKS S	Black	5438113	6117 19 8		250	VL-3Q1.5 8 W	White	5122821	6108 13 2		251
VB-SKS S	Black	5438113	6117 19 8		386	VL-3Q1.5 8 W	White	5122821	6108 13 2		390
						VL-3Q1.5 9 SW	Black	5122463	6108 10 8		251
						VL-3Q1.5 9 SW	Black	5122463	6108 10 8		390
VB-T GST18i3p	Black	5273776	6108 08 4		393	VL-3Q1.5 9 W	White	5122869	6108 13 3		251
						VL-3Q1.5 9 W	White	5122869	6108 13 3		390
VL 19028E	190 28/ St / FS	5432845	7400 96 0		206	VL-3Q2.5 1 SW	Black	5123064	6108 15 0		251
						VL-3Q2.5 1 SW	Black	5123064	6108 15 0		391
VL 19038E	190 38/ St / FS	5432883	7400 96 2		208	VL-3Q2.5 1 W	White	5123422	6108 17 5		252
						VL-3Q2.5 1 W	White	5123422	6108 17 5		391
VL 19048E	190 48/ St / FS	5432890	7400 96 4		210	VL-3Q2.5 10 SW	Black	5123248	6108 15 9		251
						VL-3Q2.5 10 SW	Black	5123248	6108 15 9		391
VL 25028E	250 28/ St / FS	5432906	7400 96 6		206	VL-3Q2.5 10 W	White	5123552	6108 18 4		252
						VL-3Q2.5 10 W	White	5123552	6108 18 4		391
VL 25038E	250 38/ St / FS	5432944	7400 96 8		208	VL-3Q2.5 11 SW	Black	5123286	6108 16 0		251
						VL-3Q2.5 11 SW	Black	5123286	6108 16 0		391
VL 25048E	250 48/ St / FS	5432951	7400 97 0		210	VL-3Q2.5 11 W	White	5123569	6108 18 5		252
						VL-3Q2.5 11 W	White	5123569	6108 18 5		391
VL 35028E	350 28/ St / FS	5432968	7400 97 2		206	VL-3Q2.5 12 SW	Black	5123293	6108 16 1		251
						VL-3Q2.5 12 SW	Black	5123293	6108 16 1		391
VL 35038E	350 38/ St / FS	5433002	7400 97 4		208	VL-3Q2.5 12 W	White	5123576	6108 18 6		252
						VL-3Q2.5 12 W	White	5123576	6108 18 6		391
VL 35048E	350 48/ St / FS	5433019	7400 97 6		210	VL-3Q2.5 13 SW	Black	5123309	6108 16 2		251
						VL-3Q2.5 13 SW	Black	5123309	6108 16 2		391
VL-3Q1.5 1 SW	Black	5122326	6108 10 0		251	VL-3Q2.5 13 W	White	5123590	6108 18 7		252
VL-3Q1.5 1 SW	Black	5122326	6108 10 0		390	VL-3Q2.5 13 W	White	5123590	6108 18 7		391
VL-3Q1.5 1 W	White	5122692	6108 12 5		251	VL-3Q2.5 14 SW	Black	5123347	6108 16 3		251
VL-3Q1.5 1 W	White	5122692	6108 12 5		390	VL-3Q2.5 14 SW	Black	5123347	6108 16 3		391
VL-3Q1.5 10 SW	Black	5122500	6108 10 9		251	VL-3Q2.5 14 W	White	5123606	6108 18 8		252
VL-3Q1.5 10 SW	Black	5122500	6108 10 9		390	VL-3Q2.5 14 W	White	5123606	6108 18 8		391
VL-3Q1.5 10 W	White	5122876	6108 13 4		251	VL-3Q2.5 15 SW	Black	5123354	6108 16 4		251

08 UFS_Katalog_2010_Neuer_Stand / en / 25/02/2010 (LLEExport_00997)

Type	Dimensions/Colour/Div.	EAN-C.	Art. no.	Price	Page	Type	Dimensions/Colour/Div.	EAN-C.	Art. no.	Price	Page
				/pc.						/pc.	
VL-3Q2.5 15 SW	Black	5123354	6108 16 4		391	VL-3Q2.5 H6 SW	Black	5124443	6108 45 5		252
VL-3Q2.5 15 W	White	5123613	6108 18 9		252	VL-3Q2.5 H6 SW	Black	5124443	6108 45 5		391
VL-3Q2.5 15 W	White	5123613	6108 18 9		391	VL-3Q2.5 H6 W	White	5124832	6108 48 0		252
VL-3Q2.5 2 SW	Black	5123101	6108 15 1		251	VL-3Q2.5 H6 W	White	5124832	6108 48 0		392
VL-3Q2.5 2 SW	Black	5123101	6108 15 1		391	VL-3Q2.5 H7 SW	Black	5124481	6108 45 6		252
VL-3Q2.5 2 W	White	5123453	6108 17 6		252	VL-3Q2.5 H7 SW	Black	5124481	6108 45 6		391
VL-3Q2.5 2 W	White	5123453	6108 17 6		391	VL-3Q2.5 H7 W	White	5124849	6108 48 1		252
VL-3Q2.5 3 SW	Black	5123118	6108 15 2		251	VL-3Q2.5 H7 W	White	5124849	6108 48 1		392
VL-3Q2.5 3 SW	Black	5123118	6108 15 2		391	VL-3Q2.5 H8 SW	Black	5124498	6108 45 7		252
VL-3Q2.5 3 W	White	5123460	6108 17 7		252	VL-3Q2.5 H8 SW	Black	5124498	6108 45 7		391
VL-3Q2.5 3 W	White	5123460	6108 17 7		391	VL-3Q2.5 H8 W	White	5124856	6108 48 2		252
VL-3Q2.5 4 SW	Black	5123125	6108 15 3		251	VL-3Q2.5 H8 W	White	5124856	6108 48 2		392
VL-3Q2.5 4 SW	Black	5123125	6108 15 3		391	VL-3Q2.5 H9 SW	Black	5124504	6108 45 8		252
VL-3Q2.5 4 W	White	5123477	6108 17 8		252	VL-3Q2.5 H9 SW	Black	5124504	6108 45 8		391
VL-3Q2.5 4 W	White	5123477	6108 17 8		391	VL-3Q2.5 H9 W	White	5124863	6108 48 3		252
VL-3Q2.5 5 SW	Black	5123163	6108 15 4		251	VL-3Q2.5 H9 W	White	5124863	6108 48 3		392
VL-3Q2.5 5 SW	Black	5123163	6108 15 4		391						
VL-3Q2.5 5 W	White	5123484	6108 17 9		252	VLE1 190	190 370/ St / FS	5099154	7404 10 0		270
VL-3Q2.5 5 W	White	5123484	6108 17 9		391	VLE1 190	190 370/ St / FS	5099154	7404 10 0		272
VL-3Q2.5 6 SW	Black	5123170	6108 15 5		251	VLE1 190	190 370/ St / FS	5099154	7404 10 0		274
VL-3Q2.5 6 SW	Black	5123170	6108 15 5		391						
VL-3Q2.5 6 W	White	5123514	6108 18 0		252	VLE1 250	250 430/ St / FS	5099161	7404 10 4		270
VL-3Q2.5 6 W	White	5123514	6108 18 0		391	VLE1 250	250 430/ St / FS	5099161	7404 10 4		272
VL-3Q2.5 7 SW	Black	5123187	6108 15 6		251	VLE1 250	250 430/ St / FS	5099161	7404 10 4		274
VL-3Q2.5 7 SW	Black	5123187	6108 15 6		391						
VL-3Q2.5 7 W	White	5123521	6108 18 1		252	VV E	/ St / FS	5433026	7400 98 0		212
VL-3Q2.5 7 W	White	5123521	6108 18 1		391						
VL-3Q2.5 8 SW	Black	5123224	6108 15 7		251	WZ 1008		5116578	7408 61 0		375
VL-3Q2.5 8 SW	Black	5123224	6108 15 7		391						
VL-3Q2.5 8 W	White	5123538	6108 18 2		252	WZ 1013		5116585	7408 61 4		375
VL-3Q2.5 8 W	White	5123538	6108 18 2		391						
VL-3Q2.5 9 SW	Black	5123231	6108 15 8		251	WZ 1014		5116615	7408 61 8		375
VL-3Q2.5 9 SW	Black	5123231	6108 15 8		391						
VL-3Q2.5 9 W	White	5123545	6108 18 3		252	WZ 1022		5116639	7408 62 6		335
VL-3Q2.5 9 W	White	5123545	6108 18 3		391						
VL-3Q2.5 H1 SW	Black	5124368	6108 45 0		252	WZ 1028		5116646	7408 63 0		245
VL-3Q2.5 H1 SW	Black	5124368	6108 45 0		391	WZ 1028		5116646	7408 63 0		335
VL-3Q2.5 H1 W	White	5124733	6108 47 5		252						
VL-3Q2.5 H1 W	White	5124733	6108 47 5		392	WZ 1029		5116677	7408 63 4		245
VL-3Q2.5 H10 SW	Black	5124542	6108 45 9		252	WZ 1029		5116677	7408 63 4		335
VL-3Q2.5 H10 SW	Black	5124542	6108 45 9		391						
VL-3Q2.5 H10 W	White	5124894	6108 48 4		252	WZ 1032		5116684	7408 63 8		375
VL-3Q2.5 H10 W	White	5124894	6108 48 4		392						
VL-3Q2.5 H11 SW	Black	5124559	6108 46 0		252	WZ 1034		5116691	7408 64 2		375
VL-3Q2.5 H11 SW	Black	5124559	6108 46 0		391						
VL-3Q2.5 H11 W	White	5124900	6108 48 5		252	WZ 1058		5116707	7408 64 6		375
VL-3Q2.5 H11 W	White	5124900	6108 48 5		392						
VL-3Q2.5 H12 SW	Black	5124566	6108 46 1		252	ZDE2-250 30	/ St / FS	5099178	7404 10 8		276
VL-3Q2.5 H12 SW	Black	5124566	6108 46 1		391	ZDE2-250 40	/ St / FS	5099185	7404 11 2		276
VL-3Q2.5 H12 W	White	5124917	6108 48 6		392	ZDE2-250 50	/ St / FS	5099215	7404 11 6		276
VL-3Q2.5 H12 W	White	5124917	6108 48 6		252						
VL-3Q2.5 H13 SW	Black	5124603	6108 46 2		391	ZE2 3	/ PA	5116745	7408 65 0		351
VL-3Q2.5 H13 SW	Black	5124603	6108 46 2		252	ZE2 3	/ PA	5116745	7408 65 0		368
VL-3Q2.5 H13 W	White	5124924	6108 48 7		392						
VL-3Q2.5 H13 W	White	5124924	6108 48 7		252	ZES4 U 1019	Grey-beige/ PA	5109358	7406 72 0		303
VL-3Q2.5 H14 SW	Black	5124610	6108 46 3		391						
VL-3Q2.5 H14 SW	Black	5124610	6108 46 3		252	ZES4 U 7011	Grey/ PA	5109310	7406 71 2		303
VL-3Q2.5 H14 W	White	5124955	6108 48 8		392						
VL-3Q2.5 H14 W	White	5124955	6108 48 8		252	ZES4 U 9011	Graphite black/ PA	5109327	7406 71 6		303
VL-3Q2.5 H15 SW	Black	5124627	6108 46 4		391						
VL-3Q2.5 H15 SW	Black	5124627	6108 46 4		252	ZES6 U 1019	Grey-beige/ PA	5109426	7406 74 0		303
VL-3Q2.5 H15 W	White	5124962	6108 48 9		392						
VL-3Q2.5 H15 W	White	5124962	6108 48 9		252	ZES6 U 7011	Grey/ PA	5109433	7406 74 4		303
VL-3Q2.5 H2 SW	Black	5124375	6108 45 1		391						
VL-3Q2.5 H2 SW	Black	5124375	6108 45 1		252	ZES6 U 9011	Graphite black/ PA	5109440	7406 74 8		303
VL-3Q2.5 H2 W	White	5124740	6108 47 6		392						
VL-3Q2.5 H2 W	White	5124740	6108 47 6		252	ZES9 10DB 7011	Grey/ PA	5436720	7406 84 4		303
VL-3Q2.5 H3 SW	Black	5124382	6108 45 2		391	ZES9 10DB 9011	Graphite black/ PA	5436737	7406 84 6		303
VL-3Q2.5 H3 SW	Black	5124382	6108 45 2		252						
VL-3Q2.5 H3 W	White	5124788	6108 47 7		392	ZES9 10U 1019	Grey-beige/ PA	5436683	7406 83 8		303
VL-3Q2.5 H3 W	White	5124788	6108 47 7		252	ZES9 10U 7011	Grey/ PA	5436669	7406 83 4		303
VL-3Q2.5 H4 SW	Black	5124429	6108 45 3		391	ZES9 10U 8014	Sepia brown/ PA	5436713	7406 84 0		303
VL-3Q2.5 H4 SW	Black	5124429	6108 45 3		252	ZES9 10U 9011	Graphite black/ PA	5436676	7406 83 6		303
VL-3Q2.5 H4 W	White	5124795	6108 47 8		392						
VL-3Q2.5 H4 W	White	5124795	6108 47 8		252	ZES9 DB 7011	Grey/ PA	5109471	7406 75 2		303
VL-3Q2.5 H5 SW	Black	5124436	6108 45 4		391	ZES9 DB 9011	Graphite black/ PA	5109488	7406 75 6		303
VL-3Q2.5 H5 SW	Black	5124436	6108 45 4		252						
VL-3Q2.5 H5 W	White	5124801	6108 47 9		392	ZES9 U 1019	Grey-beige/ PA	5109532	7406 76 8		303
VL-3Q2.5 H5 W	White	5124801	6108 47 9								

Type listing

Structure of the EAN number: Country code **40**

Manufacturer code **1219** (for articles beginning with **0: 1010**)

Individual EAN-C **5647589**

Type	Dimensions/Colour/Div.	EAN-C.	Art. no.	Price	Page				
ZES9 U 7011	Grey / PA	5109495	7406 76 0	/pc.	303				
ZES9 U 9011	Graphite black / PA	5109501	7406 76 4		303				
ZES9U HS140 1019	Grey-beige / PA	5525295	7406 69 4		304				
ZES9U HS140 7011	Grey / PA	5525240	7406 69 0		304				
ZES9U HS140 9011	Graphite black / PA	5525288	7406 69 2		304				
ZES9U HSM45 1019	Grey-beige / PA	5525233	7406 68 4		304				
ZES9U HSM45 7011	Grey / PA	5525219	7406 68 0		304				
ZES9U HSM45 9011	Graphite black / PA	5525226	7406 68 2		304				
ZESR4 U 1019	Grey-beige / PA	5109563	7406 78 0		308				
ZESR4 U 7011	Grey / PA	5109549	7406 77 2		308				
ZESR4 U 8014	Sepia brown / PA	5109594	7406 78 4		308				
ZESR4 U 9011	Graphite black / PA	5109556	7406 77 6		308				
ZESR7 10U 1019	Grey-beige / PA	5109624	7406 79 6		308				
ZESR7 10U 7011	Grey / PA	5109600	7406 78 8		308				
ZESR7 10U 8014	Sepia brown / PA	5109655	7406 80 0		308				
ZESR7 10U 9011	Graphite black / PA	5109617	7406 79 2		308				
ZESR9 U 1019	Grey-beige / PA	5109716	7406 81 6		308				
ZESR9 U 7011	Grey / PA	5109679	7406 80 8		308				
ZESR9 U 8014	Sepia brown / PA	5109723	7406 82 0		308				
ZESR9 U 9011	Graphite black / PA	5109686	7406 81 2		308				
ZESRA7 10U	/ AIG	5109730	7406 82 4		308				
ZL-SKS	Cream	6180196	6117 20 5		252				
ZL-SKS	Cream	6180196	6117 20 5		386				

Terms and conditions of sale and delivery of the companies OBO BETTERMANN GmbH & Co. KG and OBO BETTERMANN Projekt und Systemtechnik GmbH, and OBO Befestigungselemente GmbH, Menden

1. All our supplies and services shall be governed exclusively by the following terms and conditions, including our additional terms and conditions for cable tray business transactions. Any terms and conditions of business and purchasing of the customer shall be valid only if we have acknowledged them in writing. Our quotations are without engagement; they are mere invitations to submit contract offers. Any and all transactions and agreements, including those entered into by our employees and agents shall only be binding upon our written confirmation or invoicing. The foregoing provision shall also apply to any modifications of the agreed formal requirements.

2. The documents and data pertaining to the quotation, such as illustrations, brochures, drawings, dimensions, loading capacity values and weight details are approximate only, unless they are expressly stipulated to be binding.

Samples are non-binding samples for inspection. Any purchase according to sample will be subject to customary deviations and deviations resulting from normal production processes. The properties of the sample shall be no guaranteed quality of the purchase object unless expressly stated otherwise in the confirmation of order. Samples must be returned to us at the latest within four weeks in perfect condition. If they are not returned within this period in proper condition, we shall be entitled to charge the purchase price for the sample in accordance with our current price list. All information on our products, in particular the illustrations, drawings, weight, dimension and performance data included in our quotations and printed matter shall be regarded as approximate average values and shall not represent any quality guarantee.

With regard to products made according to customer drawings, samples and other instructions of the customer, we will not provide any warranty nor assume any liability for the due and proper functioning of the product or for any other defects if and to the extent they are based upon the customer's specifications. The customer shall indemnify us from any third party claims, including claims for product liability as may be asserted against us for damages resulting from the products unless we have caused such damages by intent or gross negligence. The customer shall warrant that the manufacture and supply of products made in accordance with his instructions will not infringe any proprietary rights of third parties. Should any proprietary rights be asserted against us, we shall be entitled, without any legal review of the third party claims, to withdraw from the contract after hearing the customer, unless the third party withdraws the claims asserted against us under its proprietary rights within eight days by written declaration. The customer shall compensate us for any damage sustained as a result of the assertion of proprietary rights. In case of withdrawal, the work we have carried out so far shall be remunerated. Further rights under the statutory provisions shall not be affected thereby.

Any moulds, tools and design data produced by us for the execution of the order shall be our exclusive property. Unless expressly agreed otherwise, the customer shall not have any claims thereto, even if he has contributed to the costs of producing any such moulds, tools and design data.

3. The packing, shipping route and means of transportation shall be left to our discretion in the absence of any other agreements. They shall be charged at their cost price. We will take back undamaged cases, when being returned carriage paid, at 2/3 of the amount invoiced. The one-way or pool pallets used for transport shall be either exchanged upon taking delivery or returned. The smallest packing units stocked and listed may not be broken up for rationalisation reasons. In case of orders for different quantities, the nearest packing unit will be supplied.

We reserve the right to deviate from the agreed delivery quantity, in particular in the case of custom-made products, to a customary extent or in conformity with national or international standards. In case of a demand for adhering to a precise quantity, an express reference is necessary and subject to confirmation.

Master and call orders shall oblige the customer to accept the total quantity on which the master/call order is based. Where no particular call orders are specified in the contract, the total quantity of the master call order must be called within twelve months. If the customer fails to adhere to call deadlines, we shall be entitled to deliver and charge the total quantity in full after four weeks from written notice with reference to the consequences of any failure to call. Our rights arising from any default of the customer shall not be affected thereby.

4. Unless otherwise agreed, our prices are quoted ex works and do not include packing and insurance. The value added tax at the rate applicable on the date of dispatch will be added to our prices. The purchaser shall ensure the correctness of his VAT identification number, which he must notify to us immediately without being asked. He shall undertake to inform both us and the competent domestic tax authority without delay of any change in his name, address and VAT identification number.

Delivery shall be franco domicile within Germany, i.e. carriage and packing prepaid, if the net order value is in excess of € 1,200. For small orders below € 100 (net excluding value added tax), we shall invoice a lower quantity surcharge of € 10 (net) per order. Upon transfer of our supplies and services to a carrier or forwarding agent, at the latest upon their leaving our warehouse or supply plant, the risk shall pass to the recipient, even in case of deliveries free place of destination.

5. Delivery periods and delivery deadlines shall be approximate only unless we have expressly stated in writing that they are binding. Delivery periods shall commence upon receipt of our confirmation of order, but not before clarification of all execution details, ex place of delivery. The customer shall only be entitled to withdraw from the contract after having granted a reasonable extension of time. We reserve the right to make partial deliveries. Claims for damages and reimbursement of expenses - for any reason whatsoever - shall be subject to the provisions set out in article 10.

In the event of any circumstances that are beyond our control within the scope of normal operating risks and obstruct or make impracticable any delivery, we shall be entitled to suspend delivery by the duration of such obstruction plus a reasonable start-up period or to withdraw from the contract for the part not yet fulfilled. The purchaser can demand a statement from us as to whether we wish to deliver within a reasonable period or withdraw. If we fail to make such a statement, the purchaser may withdraw. Our notice to the purchaser shall be deemed to be sufficient evidence that we have been prevented from delivering.

Delivery time is extended in case of such events as labour disputes, strikes and lockouts, orders from the authorities, difficulties with the procurement of materials, spoiled work or post-processing, shutdowns and staff shortage as well as shortage of means of transport, and general occurrence of unforeseen events beyond our scope of influence, by the length of duration of these events.

6. Payments shall be made upon receipt of invoice less a 3% cash discount for payment within 10 days or net after 30 days from date of invoice. Erection work and all paid labour work must be paid within 10 days without deduction of any cash discount. In case of non-cash payments, the date of the credit note will be deemed to be the date of receipt of payment. Payments received shall always be credited first against costs, then against interest and then against the earliest liability. Cheques and bills of exchange shall only be accepted as means of payment. Any payment by bill of exchange shall be subject to a prior separate and written agreement, whereby all bill costs shall be borne by the customer and no discount can be granted. The customer shall have no right to refuse performance and no right of retention - for any legal reason whatsoever - unless we have acknowledged his claim beforehand in writing or his claim has the force of law.

The customer shall only be entitled to set off claims which have the force of law, are undisputed or acknowledged by us in writing.

7. We shall retain title to the goods supplied by us until all our claims arising from our business transactions with the customer have been satisfied - current account clause - and all bills of exchange or cheques submitted for payment by the customer have been honoured.

Any treatment or processing of goods subject to our retention of title (reserved goods) shall be carried out for us as the manufacturer in accordance with § 950 BGB (German Civil Code) without any obligation on our part. If our reserved goods are to be regarded as the main item or the main item is owned by the customer, full title to the new item shall pass to us when it is created. In other cases, we shall acquire a co-ownership interest in the new item in the proportion of the sales value of our reserved goods to the other goods used for the new item at the time of processing, intermingling, joining or mixing. The customer shall take custody of our ownership or co-ownership interest free of charge; it shall be treated as reserved goods.

Before transfer of title, our goods shall be neither pledged nor assigned as collateral without our prior consent. In addition, any third party rights or pledges shall be notified to us immediately and we shall be given all details and provided all documents necessary for intervention; otherwise the customer must bear our loss. In the latter case, our total claims against the customer shall also be immediately payable.

The customer shall be entitled to sell or to use our reserved goods in the ordinary course of business subject to the condition that the relevant claims are transferred in accordance with article 8 below. This right shall lapse upon the customer's failure to promptly meet his payment obligations towards us or in the event of any cheque or bill protests or his suspension of payments. In such cases, we shall be entitled to take back the goods provisionally at the

customer's expense and to sell them at our duly exercised discretion after a corresponding reminder has been sent to the customer. We will then pass the due amount to the customer's credit.

8. If our goods are sold before payment of our claim, the customer shall be obliged to retain our title against his purchaser until the goods have been paid for in full by the purchaser. The claim arising against the purchaser from such resale as well as any other ancillary rights or security interests of the customer resulting from the sale and any claims for compensation in case of damage to or destruction of our reserved property, including the relevant insurance sum shall hereby be assigned to us. We hereby accept this assignment. Where our co-ownership interest is sold, the relevant claims shall be assigned in the amount corresponding to the value of our interest.

The customer shall, at our request, inform us of his purchasers, notify them of the assignment made and provide us with any and all documents required to assert our rights.

As long as the customer meets his contractual obligations without delay, he shall be authorised to collect the claims assigned. He shall keep the amounts collected on our behalf separately and remit them to us immediately as soon and as far as our claims become due. The authorisation shall lapse in case of any cheque or bill protest of the customer or his definite suspension of payments. The customer shall bear the costs incurred for any action taken against third parties and shall advance them upon request.

If the security provided to us by the retention of title and the anticipatory assignment should exceed the claims to be secured by more than 20%, we shall, at the customer's request, release paid supplies of our choice. Upon payment of all our claims by the customer, assigned claims shall pass to the customer.

9. Any complaints for obvious defects regarding the quantity or quality of our supplies and services that are identifiable upon careful inspection shall without delay, but at the latest within the period of limitation of eight days from arrival of the goods at the address of the customer or the person appointed by him, be notified in writing to us, not to our representatives. Slight deviations in dimensions and designs within the scope of defined technical tolerances shall not give rise to any right of complaint. Any rejected goods may only be returned to us with our prior written authorisation.

In case of justified complaints within the prescribed period, we shall, at our option, take remedial action by way of subsequent performance, by rectifying the defect, supplying non-defective goods or providing a credit note for the lower value calculated.

We shall be entitled to refuse subsequent performance in accordance with the statutory provisions. If we refuse subsequent performance, if any subsequent performance remains unsuccessful or if the customer cannot be reasonably expected to accept any subsequent performance, the latter shall be entitled to withdraw from the contract in compliance with the provisions of the following sentences. The customer shall only be entitled to withdraw from the contract - where a withdrawal is not excluded by law - upon the unsuccessful expiry of a reasonable period for subsequent performance set by him, unless this period was not required under the statutory provisions (§§ 281 para. 2, 323 para. 2, 440, 441 para. 1 BGB (German Civil Code)).

In case of his withdrawal, the customer shall be liable for any deterioration, destruction or loss of use resulting from any negligence or intent on his part. Any claims for damages or reimbursement of expenses of the customer shall be subject to the provisions set out in article 10.

In the case of any fraudulent concealment of a defect or in the case of any provision of a quality guarantee for the goods sold at the time of the passing of risk within the meaning of § 444 BGB (German Civil Code) (seller's declaration that the object sold has a specific property at the time of the passing of risk and that the seller, regardless of any fault on his part, intends to be answerable for any and all consequences resulting from its absence), the customer's rights shall be exclusively governed by the statutory provisions.

We shall - in addition to the statutory grounds for refusal - also be entitled to refuse subsequent performance if and as long as the customer fails to send us, at our request, the rejected goods or a sample thereof; the customer shall have no right of withdrawal for any such refusal. We may further refuse any subsequent performance if the goods concerned have been altered or modified without our consent unless the customer can prove that the defect was not caused by such alteration or modification.

The limitation period for any claims arising from defects shall be one year; in the case of goods which have been used in accordance with their intended purpose for a building and have caused its defectiveness, the limitation period shall be two years. The provisions of §§ 478, 479 BGB (German Civil Code) on recourse in the chain of suppliers shall not be affected thereby.

10. In the case of a pre-contractual, contractual or non-contractual breach of duty, including unsatisfactory delivery, tortious conduct and producer's liability, we shall only be liable for compensatory damages and reimbursement of expenses - subject to further contractual or statutory liability requirements - in the case of intent, gross negligence or slightly negligent breach of a material contractual duty (contractual duty the infringement of which jeopardises the fulfilment of the object of the contract). However - except in the case of intent - our liability shall be limited to the typical contractual damage that was foreseeable at the time the contract was entered into.

The purchaser shall not be permitted to make a claim for expenses incurred in vain.

Except for any breach of material duties, our liability for slight negligence shall be excluded, but in any case be limited to the amount of the purchase price.

Any claim asserted by the customer or a third party for payment of a contractual penalty shall be excluded.

With regard to damages caused by delay, we shall only be liable for slight negligence up to the amount of 5% of the purchase price agreed with us.

The exclusions and limitations of liability set forth above shall not apply in the event that a guarantee is given with respect to the quality of the object sold within the meaning of § 444 BGB (German Civil Code) if a defect is fraudulently concealed or in the event of injury to life, physical injury or injury to health, or strict liability under the German Product Liability Act.

Any and all claims for damages against us, for any legal reason whatsoever, shall become statute-barred at the latest after one year from delivery of the goods to the customer, in the case of tortious liability from the time of knowledge, or grossly negligent ignorance, of the circumstances giving rise to the claim and the person liable to pay damages. This provision shall not apply in the case of liability for intent and in the event that a guarantee is given for the quality of the object sold, in the case of fraudulent concealment of a defect or in the event of injury to life, physical injury or injury to health, or strict liability under the German Product Liability Act. Any shorter limitation periods shall take precedence.

11. We shall be entitled to process and store any customer data obtained with regard to or in connection with the business relationship in accordance with the German Federal Data Protection Act, irrespective of whether such data is provided by the purchaser himself or by any third parties.

12. Place of performance for delivery and payment is Menden/Sauerland. The court of competent jurisdiction for any and all disputes, including disputes with regard to bills of exchange and cheques, is the Local Court (Amtsgericht) of Menden or, at our option, the District Court (Landgericht) of Arnsberg, irrespective of the value of the object in dispute. We shall, however, also be entitled to take legal proceedings against the customer at the place of his registered office.

German law shall be exclusively applicable. The application of international purchase laws is hereby excluded.

Should, for any reason whatsoever, individual provisions of our terms and conditions of sale and delivery be invalid, the validity and binding nature of the other provisions shall not be affected thereby. The customer agrees, that the invalid provision shall be replaced by a valid provision that comes as close as possible to the economic meaning of the invalid provision.

13. The prices of products made of brass and copper are subject to certain fluctuations that are based on the relevant DEL listings. The prices of our brass articles are based on a DEL listing of € 150 for Ms 58, those of our copper products on a DEL value for electrolyte copper of € 200.

In case of any increase or reduction in these prices by more than € 15, a five per cent surcharge or deduction shall be made for each 15 points. The calculation of any such surcharges or deductions shall be based on the DEL listing of the date of our receipt of the order.

Valid from August 2004



QR-Code

With the QR Code you have direct access to our products on the Internet.

You can find further information on the QR Code at www.obo-bettermann.com.

OBO Bettermann GmbH & Co. KG

P.O. Box 1120
58694 Menden, Germany

Customer Service Germany

Tel. +49 (0)2373 891 500
Fax +49 (0)2373 897 777
E-mail: info@obo.de

www.obo-bettermann.com